



GOODWE
YOUR SOLAR ENGINE

SDT G2 SERIES USER MANUAL



GOODWE
YOUR SOLAR ENGINE

SOLAR INVERTER

V1.1
2021-08-03

Contents

01	Symbols	01
02	Safety Measures & Warning	02
03	Product Introduction	04
	3.1 Inverter Overview	04
	3.2 Dimension.....	07
	3.3 Package	08
04	Installation.....	09
	4.1 Mounting Instructions	09
	4.2 Equipment Installation	09
	4.3 Electrical Connection	12
	4.4 Communication Connection	18
05	System Operation	23
	5.1 LCD Panel and LED.....	23
	5.2 User Interface And Syetem Configuration	24
	5.3 Wi-Fi Reset & Wi-Fi Reload.....	29
	5.4 Error Message	29
	5.5 Precaution for Initial Startup	29
	5.6 Precaution for Initial Shutdown	30
	5.7 Special Adjustable Setpoints.....	30
	5.8 Voltage and frequency limits	30
	5.9 Power Recovery Rate	31
06	Troubleshooting	32
07	Maintenance.....	34
08	Technical Parameters.....	35



Failure to observe a warning indicated in this manual may result in injury



Recyclable materials



Danger of high voltage & electric shock



This side up - The package must always have the arrows point up



Don't touch, hot surface!



No more than six (6) identical packages be stacked on each other



Special disposal instructions



Fragile



Keep Dry



Refer to operation instructions



Wait at least 5 minutes after disconnecting the inverter before touching internal parts



CE mark.

02 Safety Measures & Warning

This manual contains important instructions for SDT G2 series of inverter which must be followed during installation.

The SDT G2 series inverter of Jiangsu GOODWE Power Technology Co., Ltd. (hereinafter referred to as GOODWE) strictly conforms to related safety rules in design and test. Safety regulation relevant to the location shall be followed during installation, commissioning, operation and maintenance. Improper operation may have a risk of electric shock or damage to equipment and property.(SDT G2: Dual-MPPT, Three - Phase.). Improper operation will cause serious harm to:

1. The life and well-being of the operators or a third party.
2. The inverter and other properties that belong to the operator or a third party.

Therefore the following safety instructions must be read and be always kept in mind prior to any work. All detailed work-related safety warnings and notes will be specified at the critical points in corresponding chapter. All installation and electrical work must only be performed by qualified personnel. They need to meet the standards as stated below:

- Been trained specially;
- Already completely read through and understood all related documents.
- Been familiar with safety requirements of electrical systems.

The inverter must be installed and maintained by professionals in compliance with local electrical standards, regulations and the requirements of local power authorities or companies.

- Improper handling of the device will pose a risk of injury.
- Always follow the instructions contained in the manual when moving or positioning the inverter.
- The weight of the equipment can cause injuries, serious wounds or bruise if improperly handled.
- Please install it where it is out of reach of children.
- Before installing and maintaining the inverter, it is crucial to make certain that the inverter is not electrically connected.
- Before maintaining the inverter, disconnect the connection between the AC grid and the inverter first, then disconnect the connection between the DC input and the inverter, the operator should wait at least 5 minutes after the disconnection in case of electric shock.
- All cables must be firmly attached, undamaged, properly insulated, and adequately dimensioned.
- The temperature of some parts of the inverter may exceed 60°C during operation. To avoid being burnt, do not touch the inverter during operation. Let it cool down before touching it.
- Without permission, opening of the inverter's front cover is not allowed. Users should not touch/replace any components of the inverter except the DC/AC connectors. Manufacturer assumes no responsibility for any damage to inverter or person caused by improper operation.
- The PV is not grounded under default configuration.
- Static electricity may damage electronic components. Appropriate measures must be adopted to prevent such damage to the inverter; otherwise the inverter may be damaged and the warranty will be annulled.
- Ensure that the output voltage of the proposed PV array is lower than the maximum rated input voltage of the inverter; otherwise the inverter may be damaged and the warranty will be annulled.
- If the equipment is used in a manner not specified by the manufacturer, the protection provided by the equipment may be impaired.
- When exposed to sunlight, the PV array will generate very high voltage which can cause electrical shock hazard. Please strictly follow the instruction we provided.
- PV modules should have an IEC61730 class A rating.
- Prohibit inserting or pulling the AC or DC terminals when the inverter is working. Otherwise the inverter will be destroyed.
- Only DC connectors provided by manufacturer are permitted for use, otherwise the inverter may be damaged and the warranty will be annulled.
- The inverter can exclude the possibility of DC residual currents DCI to 6mA in the system,

where an external RCD is required in addition to the built-in RCMU, and a type A RCD must be used to avoid tripping. The default photovoltaic module is not grounded. If there are more than 3 PV strings on input side, an additional fuse installation will be suggested.



The IP65 premise is that the machine is completely sealed. Please install it within one day after unpacking, otherwise please block the unconnected port and do not open it to ensure that the machine is not exposed to water and dust.

To our inverter product, GOODWE provides standard manufacture warranty which comes with the product and prepaid warranty extension solution to our customer. You can find the details about the terms and solution from below linkage.

<https://en.goodwe.com/warranty.asp>

3.1 Inverter Overview

GW4K-DT, GW5K-DT, GW6K-DT

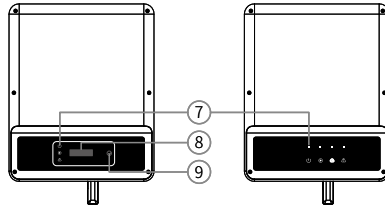
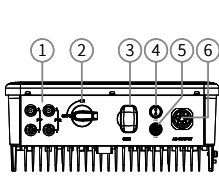

1. PV Input Terminal
2. The DC Switch (PVII)
3. Com Module
4. Smart Meter / RS485
5. DRED(6-Pin)
6. AC Output Terminal
7. Indicator Lights
8. LCD
9. Button

GW8KAU-DT, GW10KAU-DT

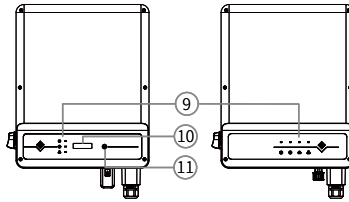
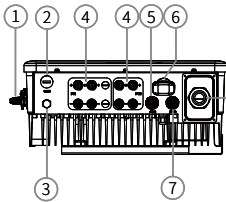

1. The DC Switch(PVII)
2. USB port
3. Waterproof Vent
4. PV Input Terminal
5. DRED(6-Pin)
(Optional)
6. Com Module
7. Smart Meter + RS485
8. AC Output Terminal
9. Indicator Lights
10. LCD
11. Button

GW15KAU-DT, GW20KAU-DT, GW17KT-DT, GW20KT-DT

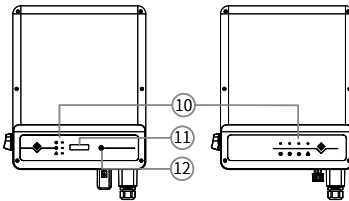
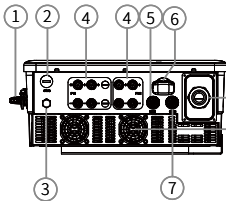

1. The DC Switch(PVII)
2. USB port
3. Waterproof Vent
4. PV Input Terminal
5. DRED(6-Pin)
(Optional)
6. Com Module
7. Smart Meter + RS485
8. AC Output Terminal
9. Fan
10. Indicator Lights
11. LCD
12. Button

GW8K-DT, GW10KT-DT

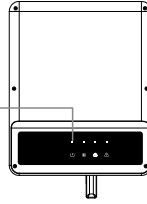
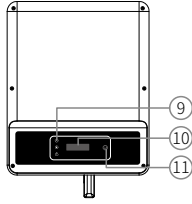
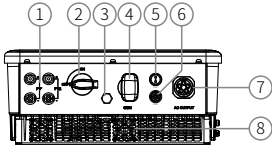

1. PV Input Terminal
2. DC Switch (Optional)
3. Waterproof Vent
4. Com Module
5. Smart Meter / RS485
6. DRED(6-Pin) / Remote shutdown(2-Pin) (Optional)
7. AC Output Terminal
8. Fan
9. Indicator Lights
10. LCD
11. Button

GW12KT-DT, GW15KT-DT

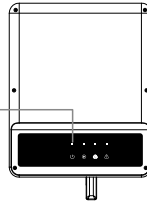
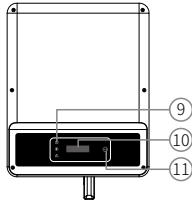
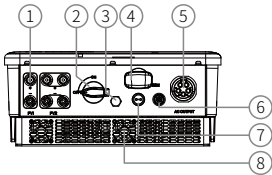

1. PV Input Terminal (SDT G2 12~15KW PV *3pair)
2. DC Switch (Optional)
3. Waterproof Vent
4. Com Module
5. AC Output Terminal
6. DRED(6-Pin) / Remote shutdown(2-Pin) (Optional)
7. Smart Meter / RS485
8. Fan
9. Indicator Lights
10. LCD
11. Button

GW25KT-DT

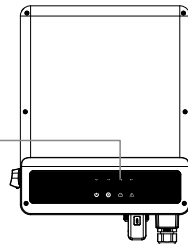
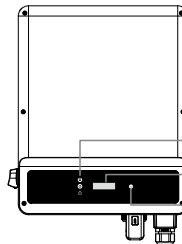
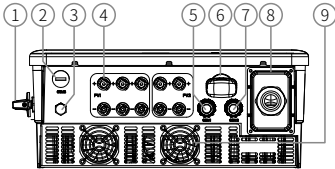

- | | | |
|--|--|---|
| <ol style="list-style-type: none"> 1. The DC switch 2. USB port (Optional) 3. Waterproof vent 4. PV input port (17/20kw PV 4 pairs, 25 KW PV 5 terminal) | <ol style="list-style-type: none"> 5. Smart Meter / RS485 6. Com module 7. DRED(6-Pin) / Remote shutdown(2-Pin) (Optional) 8. AC output port | <ol style="list-style-type: none"> 9. Fan 10. Indicator Lights 11. LCD 12. Button |
|--|--|---|

Name	Description
PV Input Terminal	For PV string connection.
The DC Switch	During normal operation it is in "on" state, it can shut down the inverter after it is disconnected from the grid by the AC breaker. The DC Switch(PVII) only for Australia.
USB Port	USB Port is used for system upgrade and configuration.
Waterproof Vent	Waterproof air permeable valve.
Com module	For Wi-Fi or LAN communication.
Smart Meter + RS485	For Smart Meter connection or RS485 communication to prevent current backflow.
DRED(6-Pin) / Remote Shutdown (2pin)	DRED only for Australia.
AC Output Terminal	For AC cable connection.
Fans	For inverters of 15kW and 20kW power only. There are two Fans to perform controlled force-air cooling.
Indicator light	Display the state of the inverter.
LCD	Inverter operation data viewing and parameter configuration.
Buttons	For configuration and viewing parameters.

3.2 Dimension

Dimensions of GW4K-DT, GW5K-DT, GW6K-DT:

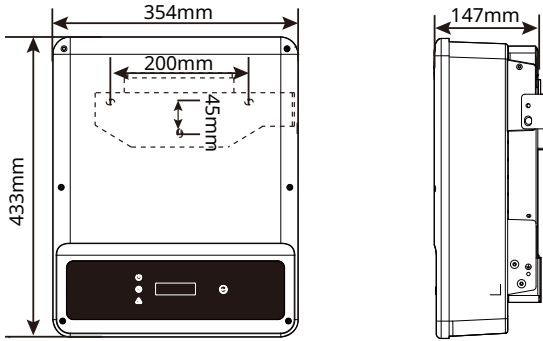



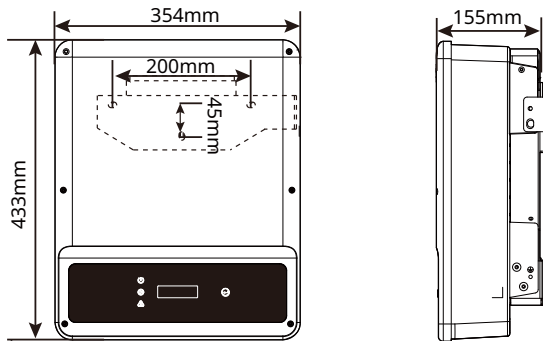



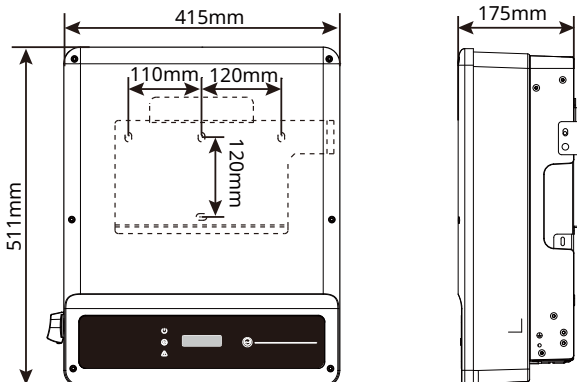



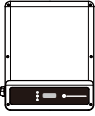
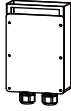
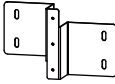



Dimensions of GW8K-DT, GW10KT-DT, GW12KT-DT, GW15KT-DT:

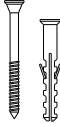

Dimensions of GW8KAU-DT, GW10KAU-DT, GW15KAU-DT, GW20KAU-DT, GW17KT-DT, GW20KT-DT, GW25KT-DT:

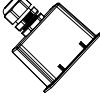

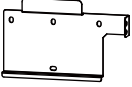
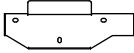
3.3 Package

 Inverter*1	 PV Box*1	 PV Box Bracket*1	 Positive PV Connector	 Negative PV Connector
 Cross Screwdriver*1	 PE OT Terminal*1	 AC PIN Terminal*6	 Communication Connector[1]	 Screw
 Expansion Bolt	 Communication Module*1[2]	 AC Connector*1[3]	 AC Connector*1[3]	 Mounting Bracket*1[4]
 Mounting Bracket*1[4]	 PIN Terminal	 Documentation *1		

- The number of expansion bolts, screws, PV connectors, and PIN terminals are various depending on the different inverters. The actual accessories may differ.
- Communication module types including WiFi, 4G, LAN, GPRS, Bluetooth, etc. The actual module delivered depends on the communication method of the selected inverter.
- The model of the AC connector and mounting bracket are various depending the different inverters. The actual accessories may differ.
- Only model GW15KAU-DT and GW20KAU-DT are equipped with PV box and PV box bracket.

4.1 Mounting Instructions

1. In order to achieve optimal performance, the ambient temperature should be lower than 45°C.
2. For easy maintenance, we suggest to install the inverter at eye level.
3. Inverter should not be installed near flammable and explosive items. Strong electro-magnetic charges should be kept away from installation site.
4. Strong electro-magnetic charges and obstructions should be kept away from installation site to ensure signal strength.
5. Product label and warning symbols should be placed at a location that is easy to read by the users.
6. Make sure to install the inverter at a place where it is protected from direct sunlight, rain and snow.

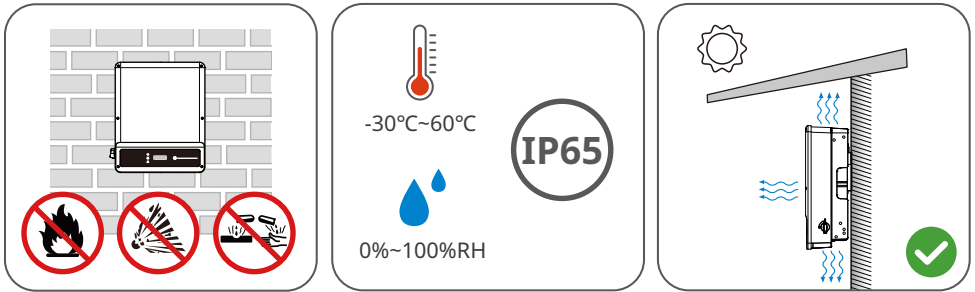

4.2 Equipment Installation

4.2.1 Select the Installation Location

1. Take the bearing capacity of the wall into account. The wall (such as concrete walls and metal structures) should be strong enough to hold the weight of the inverter over a long period of time.
2. Install the unit where it is accessible to service or do the electrical connection.
3. Do not install the unit on the wall of flammable material.
4. Make sure the installation location is well ventilated.
5. Inverter should not be installed near flammable or explosive items. Any strong electro-magnetic equipment should be kept away from installation site.
6. Install the unit at eye level to for convenient operation and maintenance.
7. Install the unit vertically or tilted backwards of no more than 15 degrees, no lateral tilt is allowed. And wiring area should be facing downwards. Horizontal installation requires more than 250mm off the ground.

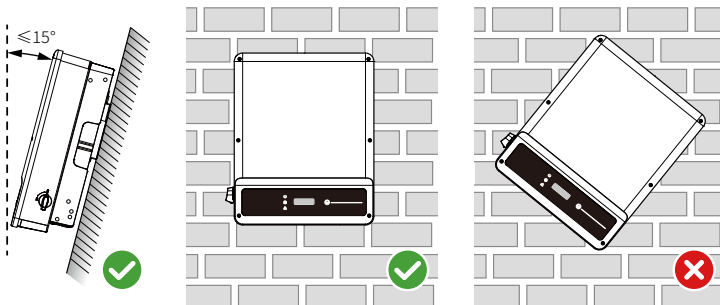

For dissipation of heat and convenience of dismantling, clearances around the inverter must meet the standard as shown below :

The installation position should not prevent access to the disconnection means.

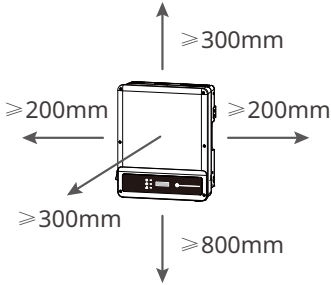

Note: Inverters of 15kW or 20kW power need a clearance of 800mm to the ground at least.

4.2.2 Mounting Procedure

Avoid the water pipes and cables buried in the wall when drilling holes.

1. Use the wall-mounted bracket as a template and drill holes in the wall, 10 mm in diameter and 80mm deep.
2. Fix the wall-mounted bracket on the wall by using the expansion bolts in the accessories bag.
3. Hold the inverter by the side groove.
4. Install the inverter on the wall-mounted bracket.

Installation method of GW4K-DT, GW5K-DT, GW6K-DT, GW8K-DT, GW10KT-DT, GW12KT-DT, GW15KT-DT inverter:

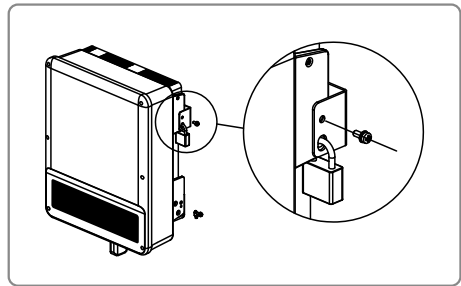
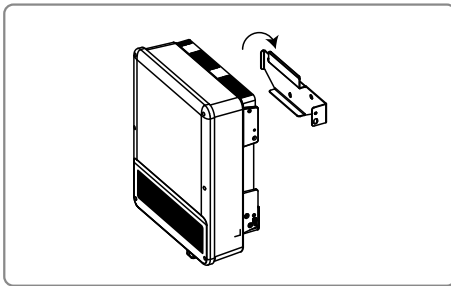
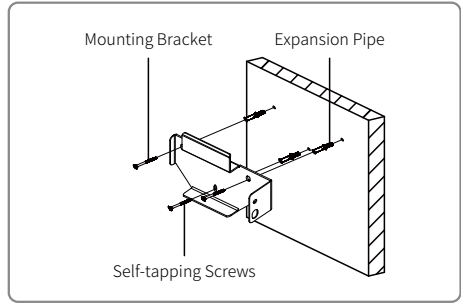
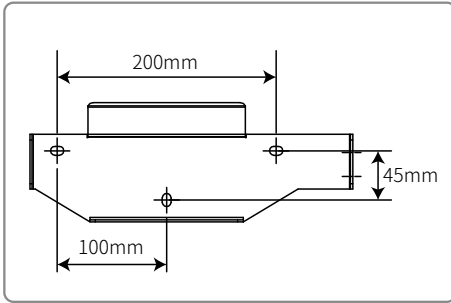

Installation method of GW8KAU-DT, GW10KAU-DT, GW15KAU-DT, GW20KAU-DT, GW17KT-DT, GW20KT-DT, GW25KT-DT inverter:

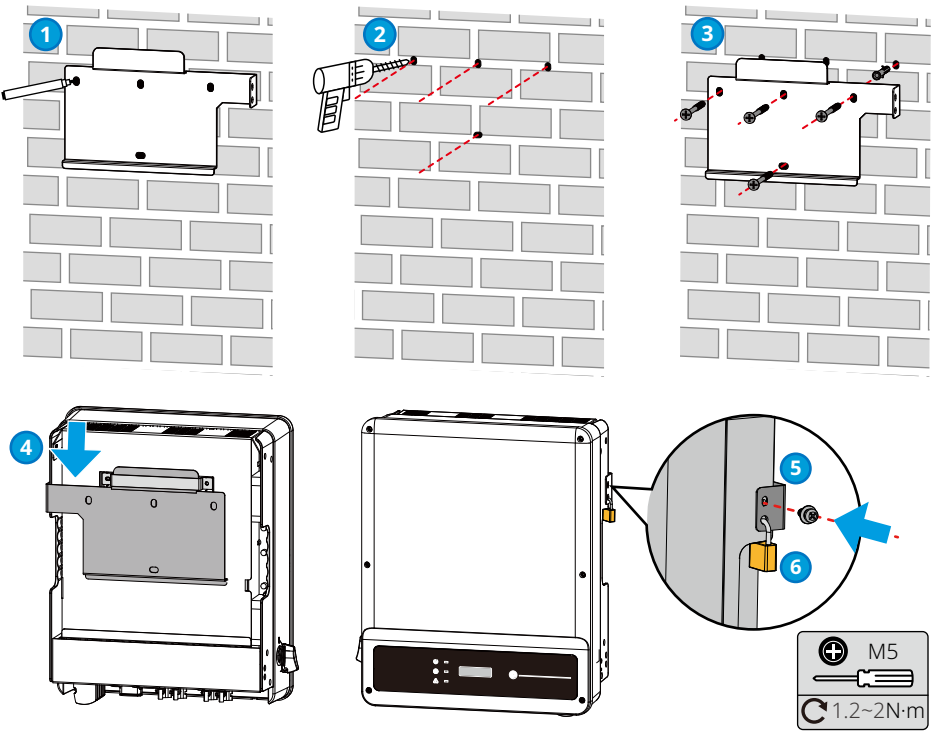

Install the PV box as following only when model GW15KAU-DT or GW20KAU-DT is used.

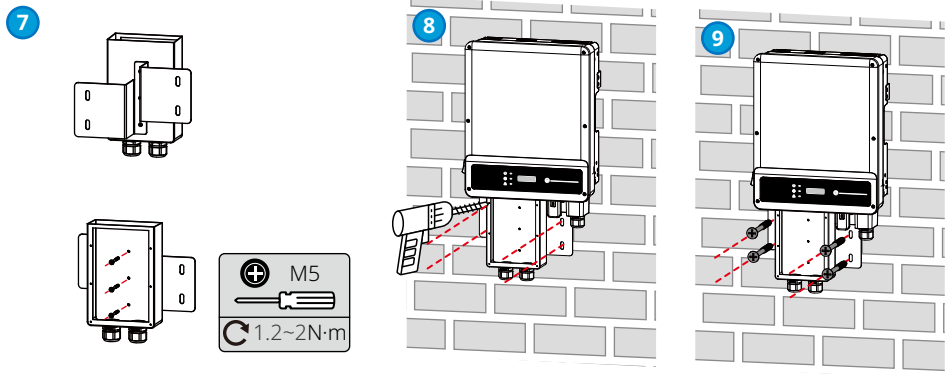

4.3 Electrical Connection

4.3.1 Connection to Grid (AC Side Connection)

1. Measure the voltage and frequency of grid-connected access point, and make sure it is in accordance with the grid-connected standard of inverter.
2. It is recommended to add breaker or fuse to AC side. The specification should be more than 1.25 times of rated of AC output current.
3. The PE line of inverter should be connected to the earth, make sure that the impedance between the neutral wire and earth wire is less than 10 ohm.
4. Disconnect the breaker or fuse between the inverter and the utility.
5. Connect the inverter to the grid as follows: The wiring installation method on the AC output side is shown as below.
6. The AC line construction shall be such that if the cord should slip from its anchorage, placing a strain on conductors, the protective earthing conductor will be the last to take the strain, such as the PE line is longer than L and N.

GW4K-DT, GW5K-DT, GW6K-DT, GW8K-DT, GW10KT-DT, GW12KT-DT, GW15KT-DT;

There is only one type of AC connector, VACONN Series.



The installation instruction of VACONN series.

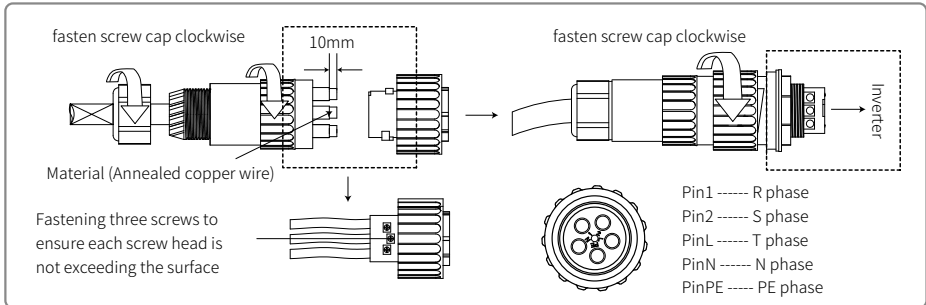

Cable specification of AC side .

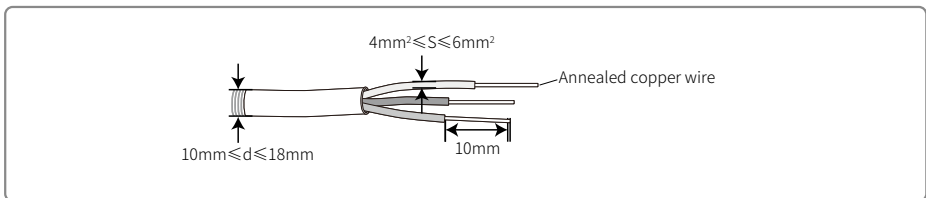

* Neutral conductor shall be blue, line conductor shall be black or brown (preferred), protective earth bonding line shall be yellow-green.

* Fix the connector of the AC cable to the corresponding terminals (tightening torque: $0.6 \text{ N} \cdot \text{m}$)

GW8KAU-DT, GW10KAU-DT, GW15KAU-DT, GW17KT-DT, GW20KT-DT, GW20KAU-DT, GW25KT-DT connection:

If the line used is small, please use the attached fire mud to block, ensure the AC terminal waterproof grade.

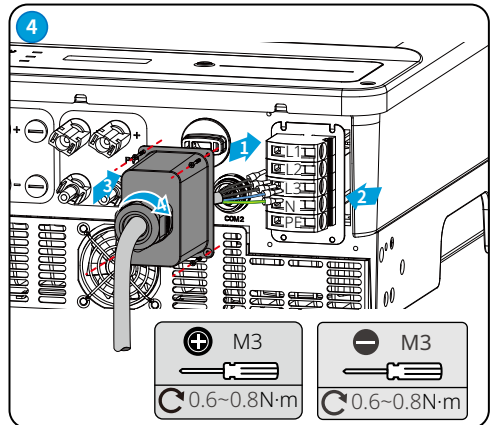
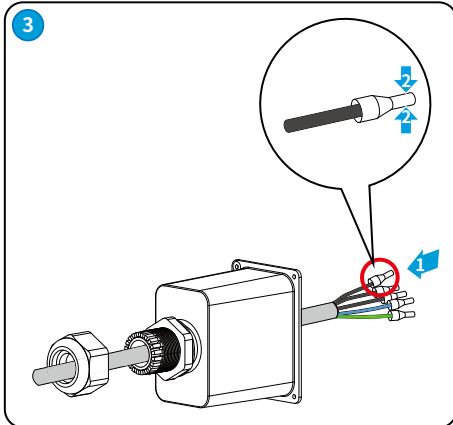
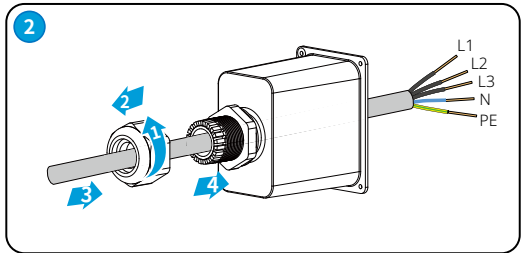
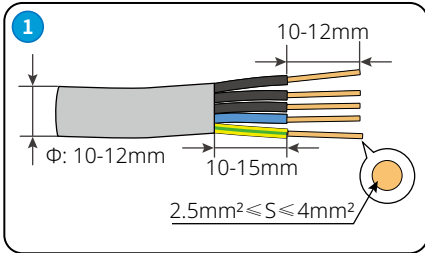
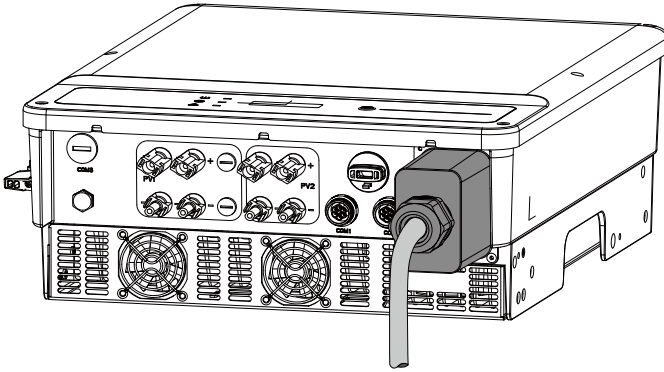

4.3.2 AC Circuit Breaker and Leakage Current Protection Device

In order to ensure that the inverter can be safely and reliably disconnected from the power grid, please install an independent two pole circuit breaker to protect the inverter.

Inverter model	Recommended circuit breaker specifications
GW4K-DT, GW5K-DT, GW6K-DT	16A
GW8K-DT, GW8KAU-DT, GW10KT-DT, GW10KAU-DT	25A
GW12KT-DT, GW15KT-DT, GW15KAU-DT, GW17KT-DT	32A
GW20KT-DT, GW20KAU-DT	40A
GW25KT-DT	50A

Note: Multiple inverters are not allowed to share a circuit breaker.

The integrated leakage current detection device of the inverter can detect external leakage current in real time. When the detected leakage current exceeds the limit value, inverter will quickly disconnect from the grid, If the leakage current protection device is installed externally, the action current should be 300mA or higher. Please use Type A for RCD.

4.3.3 DC Side Connection

1. Before connecting the PV strings, please ensure that the plug connectors have the correct polarity. Incorrect polarity could permanently damage the unit.
2. The open circuit voltage of the PV strings cannot exceed the maximum input voltage of the inverter.
3. Only DC connectors provided by manufacturer are permitted for use.
4. The positive and negative pole are not allowed to connect to the PE wire (Ground wire). Otherwise, it will damage the unit.
5. Do not connect positive or negative pole of PV string to PE wire. Otherwise, it will cause damage to inverter.
6. Positive cable shall be red, negative cable shall be black.
7. The minimum insulation resistance to ground of the PV panels for SDT G2 series must exceed $33.4K\Omega$ ($R=1000/30mA$). There is a risk of shock hazard if the requirements of minimum resistance are not met.

There are four types of DC connectors, DEVALAN, SUNCLIX/MC4, AMPHENDL H4 and QC4.10 series. DC terminals have to be used with the product of same model.

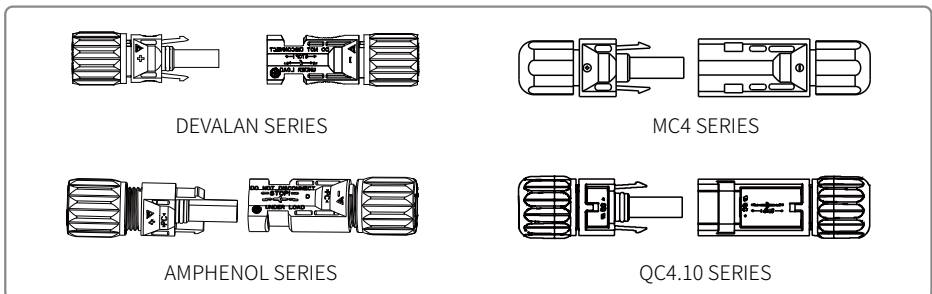

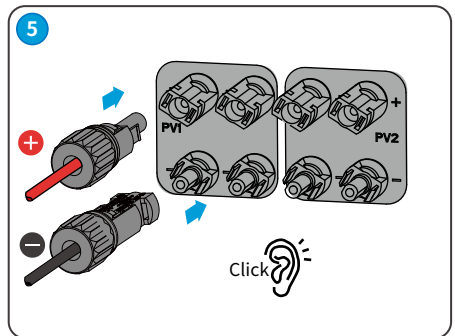
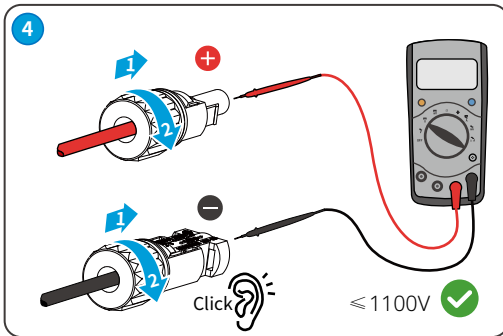
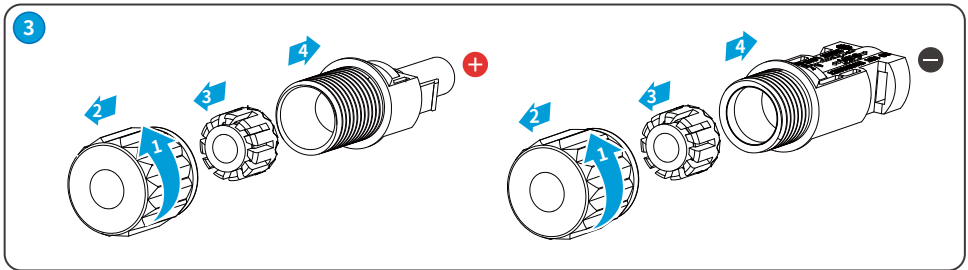
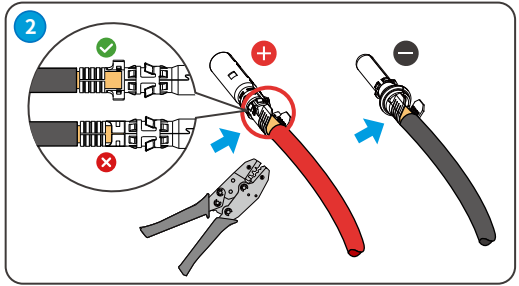
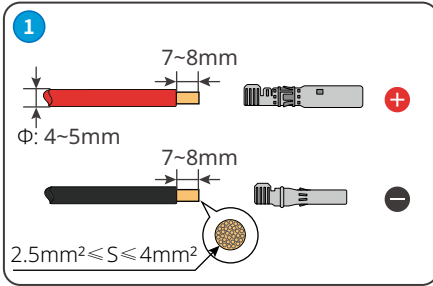
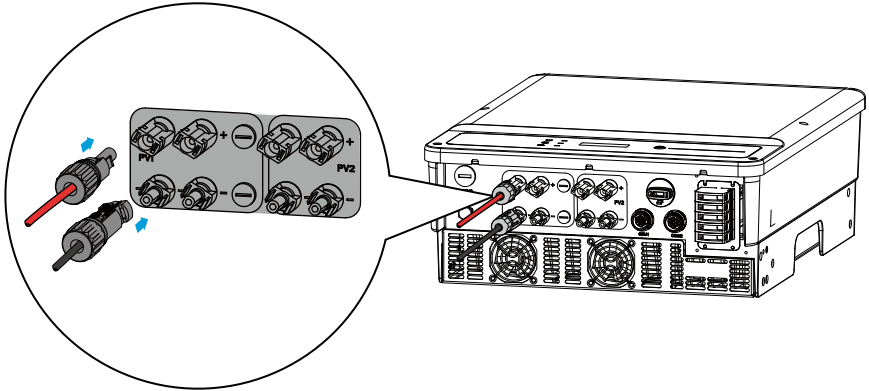

When installing model GW15KAU-DT or GW20KAU-DT, thread the DC cable through the PV box, and connect the cable to the PV connectors first. Then plug the PV connectors into the inverter, and fasten the top cover of the PV box.

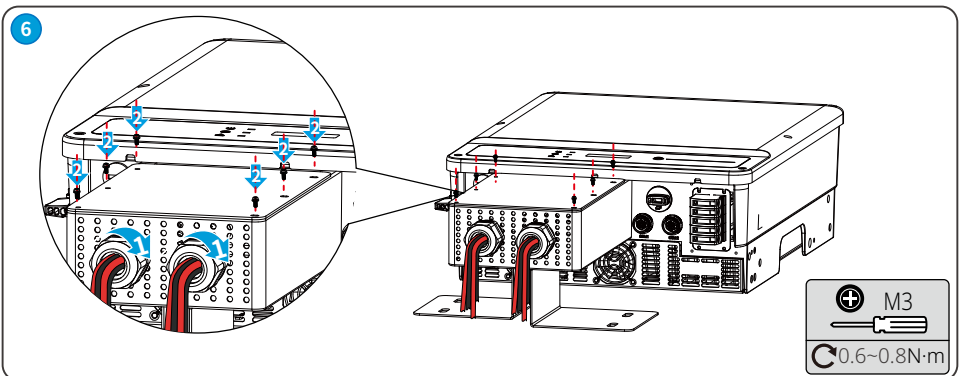
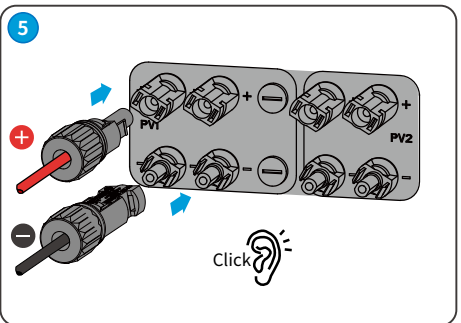
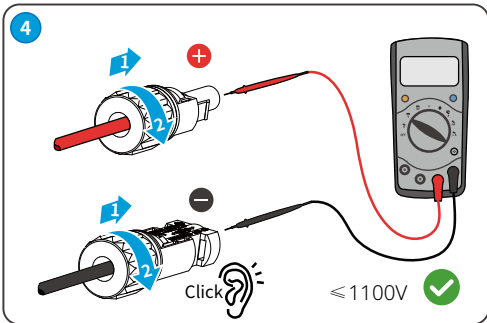
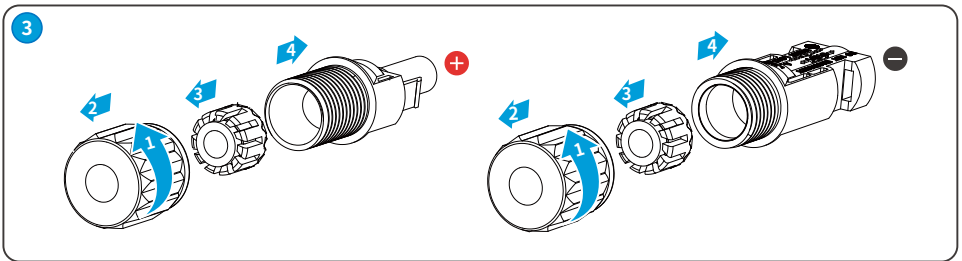
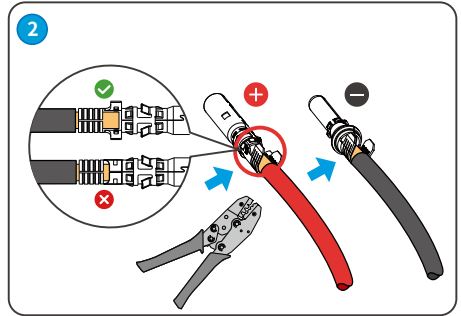
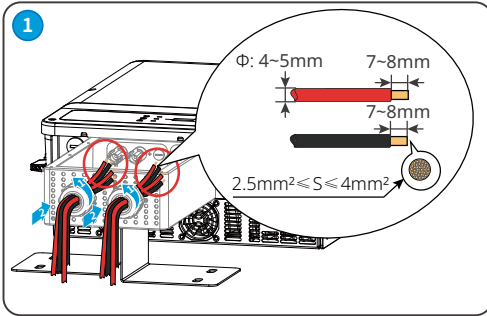

4.3.4 Earth Terminal Connection

The inverter is equipped with earth terminal according to the requirement of EN 50178. All non-current carrying exposed metal parts of the equipment and other enclosures in the PV power system must be grounded permanently. Please follow the steps below to connect "PE" cable to ground.

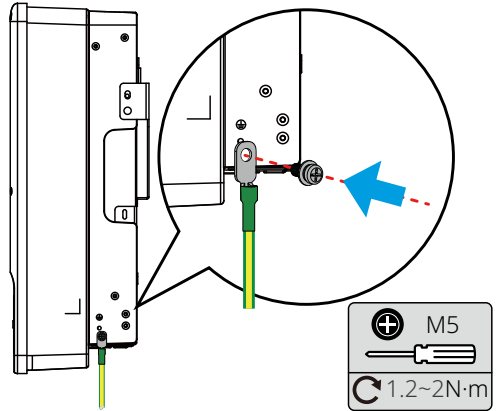
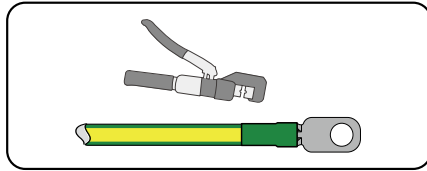
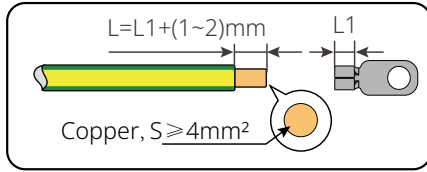

4.4 Communication Connection

4.4.1 Wi-Fi Communication

The appearance of communication modules is slightly different. But the modules are installed in the same way. The following figure shows you how to install a WiFi module.

The Wi-Fi communication function is only applicable if the inverter has a Wi-Fi module. The detailed configuration instruction please refer to "Wi-Fi Configuration Instruction" in the accessory box.

After configuration, please browse www.semsportal.com to create PV Plant.

The Wi-Fi module installation of SDT G2 4~6KW are shown as below.

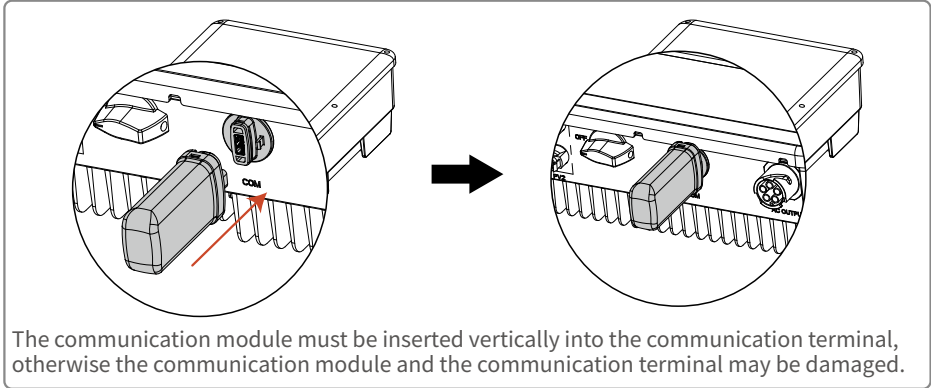

The Wi-Fi module installation of SDT G2 8~20KW are shown as below.

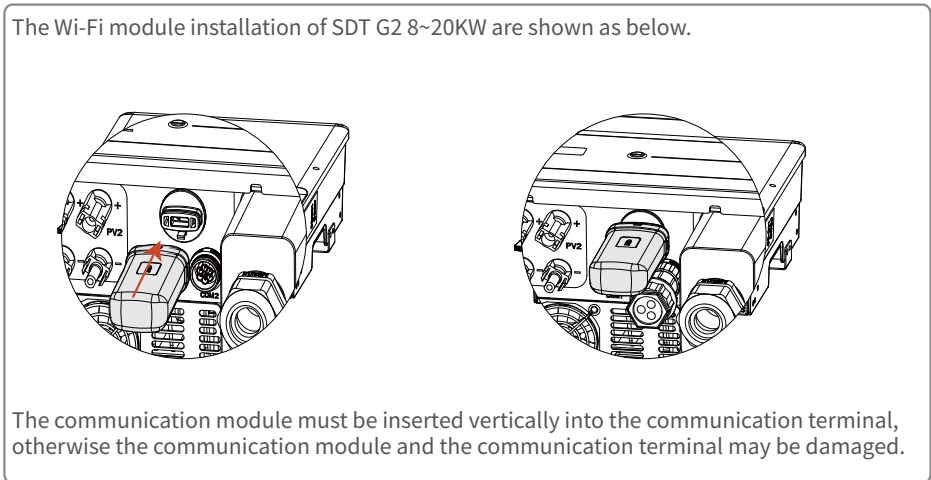

4.4.2 USB Communication Connection

This function only applies to the local firmware upgrade and parameter calibration for after-sales.

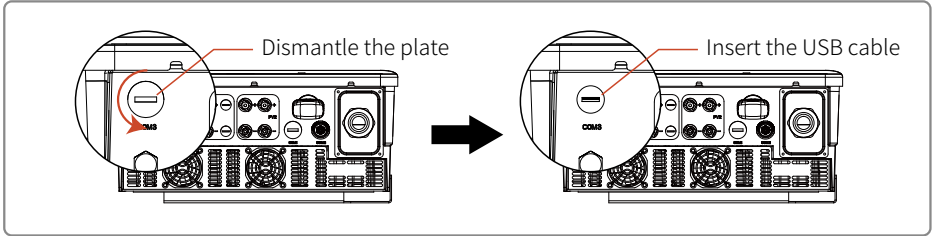

4.4.3 Export Power Limit Connection Diagram

The methods of connecting the Power Limiting device is shown below.

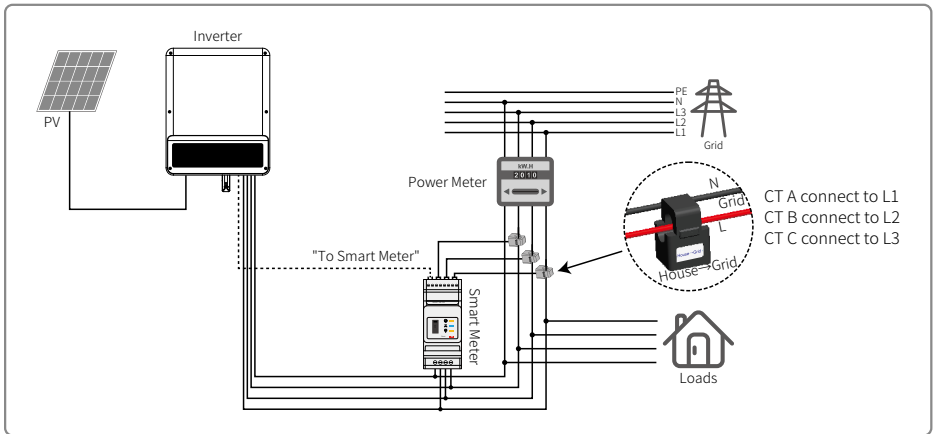

4.4.4 DRED / Smart Meter (Power Limit Device) /RS485 Connection

DRED (Demand Response Enabling Device) is available only for installation in Australia and New Zealand, in compliance with local safety regulations. The connection port from inverter is reserved but the device shall not be provided as standard component by inverter manufacturer. DRED should be connected to the COM port with 6-Pin.

Connecting the DRED Cable (6PIN)

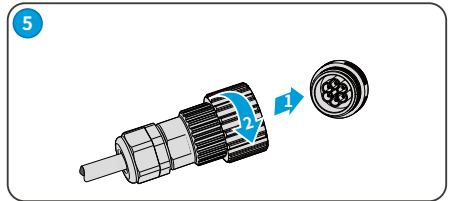
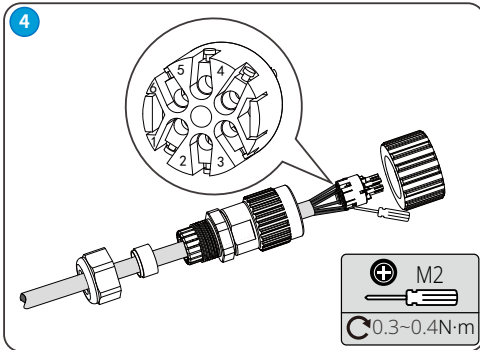
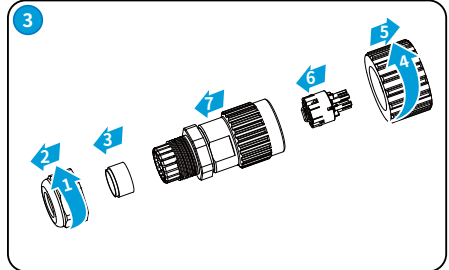
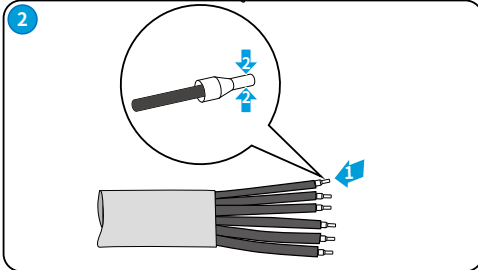
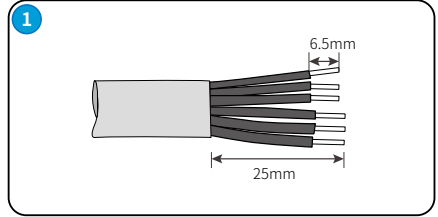
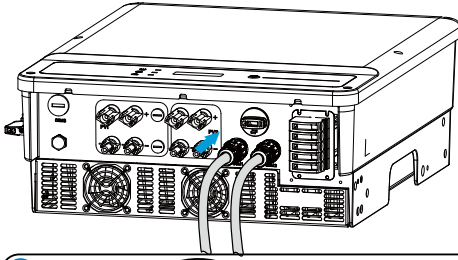

No.	Function
1	DRM1/5
2	DRM2/6
3	DRM3/7
4	DRM4/8
5	REFGen
6	COM/DRM0

Connecting Smart Meter and RS485 Cable (6PIN)

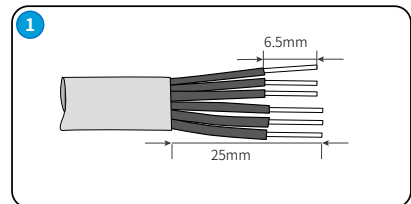
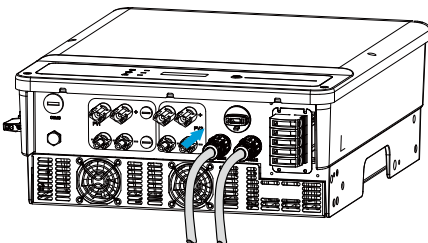

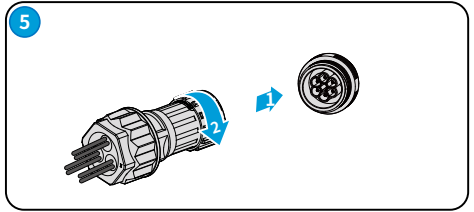
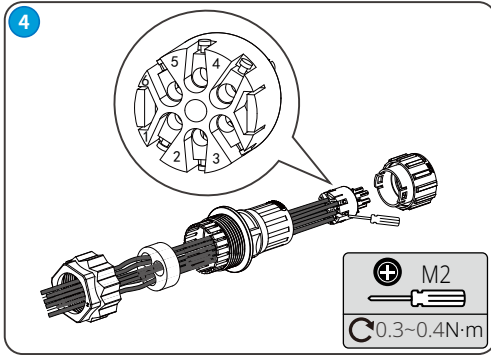
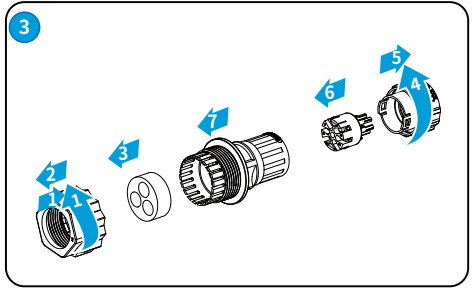
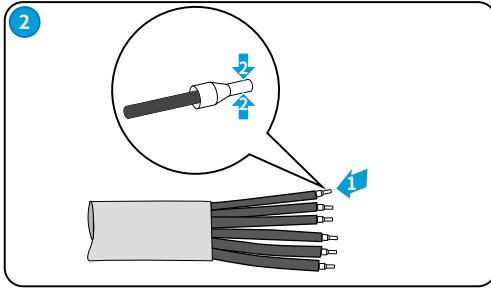

NO.	Function
1	RS485 B
2	RS485 B
3	RS485 A
4	RS485 A
5	Meter +
6	Meter -

Connecting Smart Meter/RS485 Cable (2 PIN)

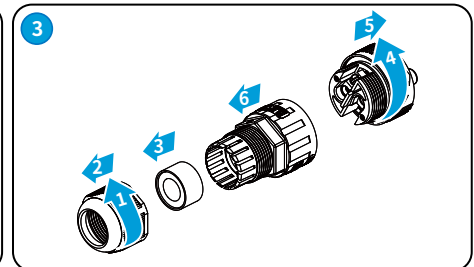
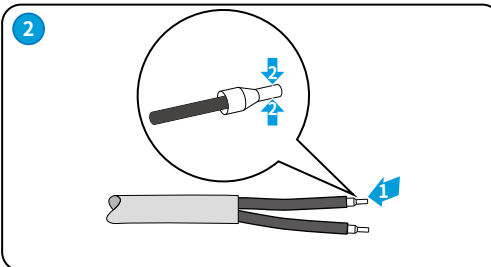
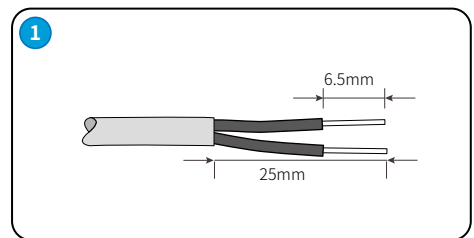
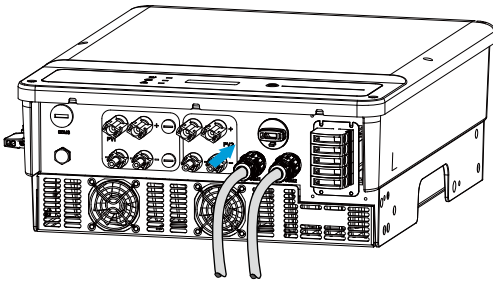

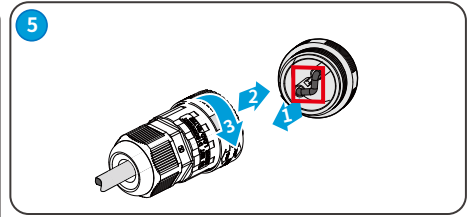
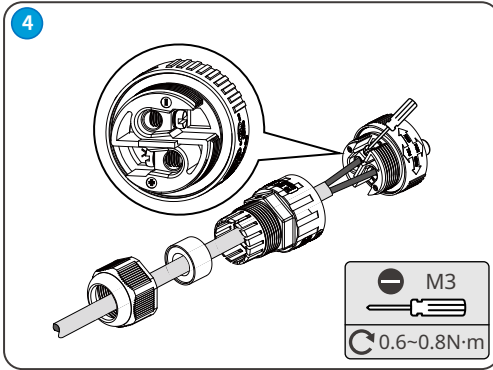

NO.	Function
+	METER+/RS485 A
-	METER-/RS485 B

Note:

1. Meter is not a standard accessory for grid-tied inverter. You may contact sales if meter is in need.
2. The compatible DRM commands are DRM0, DRM5, DRM6, DRM7, DRM8.
3. You may refer to guidance in Smart Meter User Manual if meter is required.
4. DRED option is available only for Australia and New Zealand.
5. To implement export power limitation, meter is required to install in the system. The function should be enabled and threshold value set on local LCD or SolarGo by following the steps at section "5.2 User Interface and System Operation".

4.4.5 Earth Fault Alarm

In compliance with the section 13.9 of IEC62109-2, the SDT G2 series inverter is equipped with an earth fault alarm. When earth fault occurs, the fault indicator at the front LED screen will light up. On inverter with Wi-Fi communication, the system sends an email with the fault notification to the customer. For inverter without Wi-Fi, the buzzer of the inverter will keep ringing for one minute and ring again after half an hour until the fault is resolved. (This function is only available in Australia and New Zealand).

4.4.6 SEMS Portal

SEMS Portal is an online monitoring system. After completing the installation of communication connection, you can access www.semsportal.com or download the App by scanning the QR code to monitor your PV plant and device. Please contact the after-sales for more operation of SEMS Portal.



SEMS Portal App

5.1 LCD Panel and LED

As a human-computer interaction interface, LCD display panel comprises of LED indicators, buttons and LCD display on the front panel of the inverter. LED indicates the working status of the inverter. Buttons and LCD are used for configuration and viewing parameters.



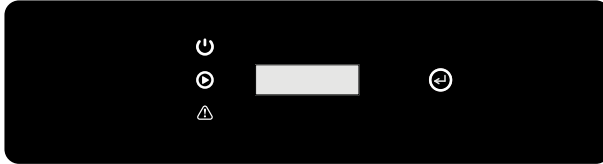





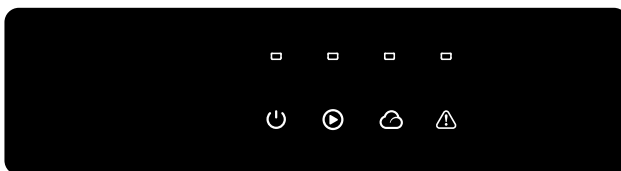





Inverters Designed with LCD



Indicator	Status	Description
 Power		Steady Yellow The communication module is working properly.
		Double Yellow Blinking The inverter is not connected to the router.
		Quartic Yellow Blinking The inverter is not connected to the monitoring website.
 Operating		Steady Green The power grid is working properly. The inverter is on grid.
		Single Green Slow Blinking Self-check before grid tying.
		Single Green Fast Blinking The inverter is to be grid-tied.
		Off The inverter is off grid.
 Faulty		Steady Red System fault.
		Off No fault.

Inverters Designed without LCD



Indicator	Status	Description	
 Power		Steady Green	Power on
		Off	Power off
 Operating		Steady Green	The power grid is working normally.The inverter is on grid.
		Off	The inverter is off grid.
		Single Green Slow Blinking	Self-check before grid tying.
		Single Green Fast Blinking	The inverter is to be grid-tied.
 SEMS		Steady Green	The Communication module is working properly.
		Double Green Blinking	The inverter is not connected to the router.
		Quartic Green Blinking	The inverter is not connected to the monitoring website.
 Faulty		Steady Red	System Fault.
		Off	No fault.

5.2 User Interface And System Configuration

5.2.1 Operation Method

There are two modes of button operation: Short press the button and long press the button. In all levels of menu, if no action is taken, the backlight of the LCD display will switch off, the display will automatically revert to the first item of the first level menu, and any modifications made to the data will be stored into internal memory.

5.2.2 Set Safety Country

After powering on for the first time, the inverter prompts **Select Country/Region**, please short press until "GW15KT-DT Pac=****.0W" is displayed, and then set the safety region. The inverter cannot be connected to the grid before the safety-related area is set. If display shows "GW15KT-DT Pac=****.0W", then long press the button to enter the second level menu. Short press to browse the countries available. Please wait after choosing the suitable country's safety setting, the display will show "setting..." and skip to "Set OK" or "Set Fail".

NOTE: For the Australian market, to comply with AS/NZS 4777.2:2020, please select from Australia Region A/B/C, please contact your local electricity grid operator on which Region to select. After the safety area setting is completed, some parameters in the inverter system will take effect according to the corresponding safety regulations, such as PU curve, QU curve, trip protection, etc. If you need to change the configuration parameters, please refer to the SolarGo APP user manual.

5.2.3 Display

A schematic of the display screen is shown as below:

Normal
Pac=6000.0W

Display area is divided as follows:

Line 1
Line 2

5.2.4 Display Area

Line 1--Working status information

This area displays the status information. "Waiting Pac=0.0W" indicates the inverter is standing by for power generation; "Checking**S Pac=0.0W" (checking time is based on safety, and varies from country to country) indicates the inverter is self-checking, counting down and preparing for power generation. "Normal Pac=6000.0W" indicates the inverter is generating power. If any condition of the system is abnormal, the screen will display an error message.

Through Button operation, the screen can display different information such as operation parameters and power generation status in this area. There are two levels of menus, and the flow chart of first level menu is shown as the diagram.

5.2.5 Use of LCD

The display allows accessing the configuration of the basic parameters. All the language, time and country settings can be configured by buttons. The menu, shown in the LCD displays area has two levels of menu. Short or long press the button will take you between menus and through each menu. Items in the first level menu that have no second level are locked. For these items, when the button is pressed for two seconds, the LCD will display the word "Lock" followed by data relating to the first level menu item. The locked menu can only be unlocked under system mode switching, fault occurrence or button operation.

5.2.6 Menu Introduction

When the PV panel is feeding power to the inverter, the screen will show the first-level menu.

- The initial display is the the first item of the first level menu, and the interface displays the current status of the system, It shows "Waiting Pac=0.0W" in the initial state; it shows "Normal Pac=6000.0W" during power generation mode; if there is something wrong with the system, an error message is shown.

The way to view PV voltage, PV current, grid voltage, current and frequency:

- Short press the button to enter the E-Today menu which displays the total power generation for today.
- Short press the button to enter the E-Total menu which displays the total power generation up to today.
- Short press the button to enter the Vpv menu which displays the PV voltage in "V".
- Short press the button to enter the Ipv menu which display sthe PV current in "A".
- Short press the button to enter the Vac menu which displays the grid voltage in "V".
- Short press the button to enter the Iav menu which displays the grid current in "A".
- Short press the button to enter the Frequency menu which displays the grid frequency in HZ.
- View error message.

Short press the button once more to enter the "Error Message History" menu.

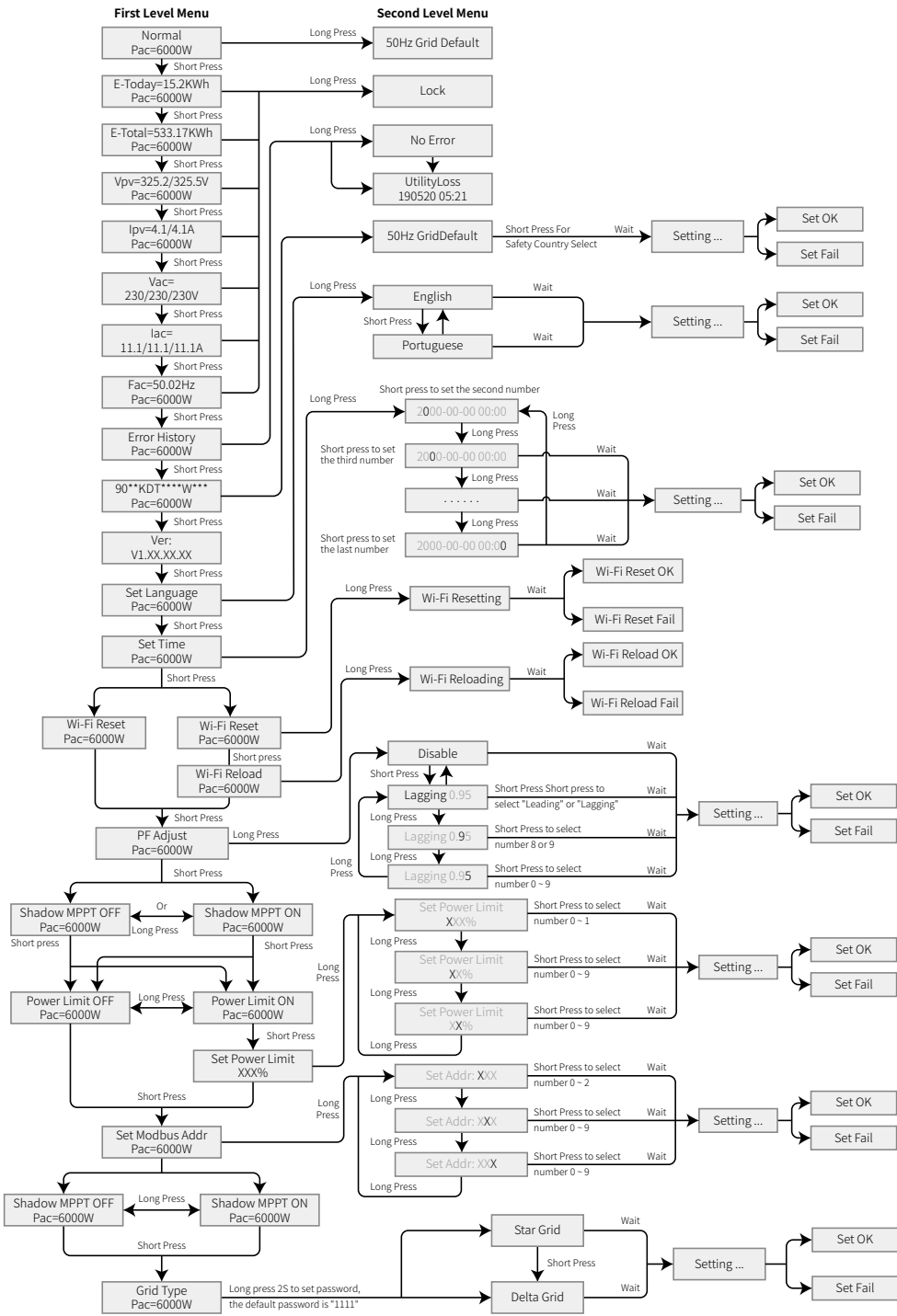

Long press the button to enter the second level menu of error detection. The newest three inverter error message will be shown by short pressing the button in this second level menu. The records include error message and error times (190520 15:30).

- The way to view model name and reconfigure safety country:

From the error message history item in the first level menu, short press the button to check the model name.

If you want to change the safety country setting, please long press the button to enter the second level menu.

In the second level menu, you can change the safety country with short pressing the button. If you change the safety country, the display will show: "Setting...". Then the display will show: "Set Fail" or "Set OK" 10 seconds later. If you do nothing in second level menu and without pressing button, the backlight of display will power off and return to the first level menu.

- View software version

From the model name item in the first level menu, short press the button once to see software version.

The current software version can be shown in this menu.

5.2.7 Basic Setting

- Set language:

Short press the button to enter the "Set Language" menu. Long press the button to enter the second level menu. Short press the button to browse the languages available.

- Set time:

From the first level "Set Language" menu, short press the button to enter the "Set Time" menu.

Long press the button to enter the second level menu. The initial display is "2000-00-00 00:00", in which the first four numbers represent the year (e.g. 2000~2099); the fifth and sixth numbers represent the month (e.g. 01~12); the seventh and the eighth numbers represent the date (e.g. 01~31). The remaining numbers represent the time.

Short press the button to increase the number in current location, and press to move the cursor to next position.

- Set protocol:

This function is only opened for service personnel, setting a wrong protocol could lead to communication failure.

From the first level Set Time menu, short press the Button once to enter protocol display menu.

Press the Button for 2s to enter submenu. The circulatory submenu that includes two protocols can be found. The protocol can be chosen by short pressing the Button. The inverter will store the chosen protocol if there is no input for 10 seconds and LCD display will automatically return to main menu and the backlight will be turned off.

- MPPT function for Shadow:

The default setting for shadow optimizer is disabled.

Please do not enable the function when there is no shadow on panel. Otherwise it could lead to generating less power.

Press the Button to enter Shadow Optimize menu. When it shows "Shadow MPPT OFF", it means the shadow optimizer is on. Press the Button for 2s to disable the function.

5.2.8 Power Limiting Function Setting

The Operations of the ON/OFF power limiting function (the default is OFF) and the power limiting settings (the default is 2% rated) are shown as below.

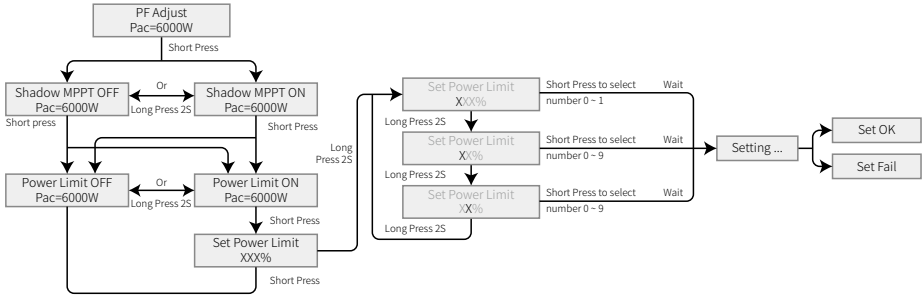

such as a CT/Meter or the power limiting device is not working.

You need to enter a password before being able to set the power limit. . The default password is "1111".(only for Australian security regulations)

5.2.9 Operation of Display When Commissioning

When the input voltage reaches the inverter's turn-on voltage, the LCD starts to work, the yellow light is turned on and the LCD displays "Waiting". More information will be displayed within a few second. If the inverter is connected to the grid, "Checking XXs" will be displayed and a countdown will commence from 30 seconds. When it shows "00S", you will hear the relay be triggered 4 times. Then the LCD will display "Normal". The instant power output will be shown at the bottom left of the LCD.

5.2.10 Arc Function Setting

The Arc function interface is displayed only when the arc board is connected. The Arc function switch is ENABLE by default.

Arc setting process is showing as below.

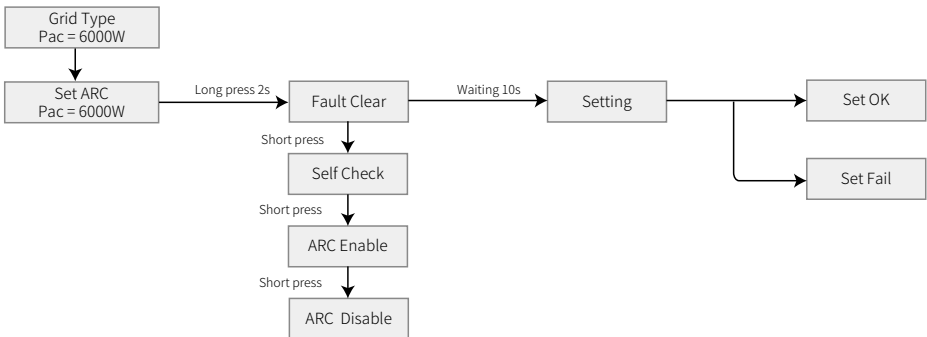

5.3 Wi-Fi Reset & Wi-Fi Reload

These functions are only available for Wi-Fi model inverter.

Wi-Fi reload function is used to change the Wi-Fi configuration to default value. Please configure the Wi-Fi again after using the function.

Short press the button until the LCD displays "Wi-Fi Reset", then long press the button until the LCD displays "Wi-Fi Resetting...". Stop pressing and wait for the screen to display "Wi-Fi Reset OK" or "Wi-Fi Reset Failed".



Press the Button until the LCD displays "Wi-Fi Reload", then long press until the LCD displays "Wi-Fi Reloading...". Stop pressing and wait for the screen showing "Wi-Fi Reloading OK" or "Wi-Fi Reloading Failed".



5.4 Error Message

An error message will be displayed on the LCD if a fault occurs.

Error message	Description
Fac Fail	Grid frequency out of permissible range.
Isolation Fail	Ground insulation impedance is too low.
Vac Fail	Grid voltage out of permissible range.
PV Over Voltage	Overvoltage at DC input.
Over Temperature	Over temperature on the case.
Utility Loss	Utility is unavailable.

5.5 Precaution for Initial Startup

1. Make sure the AC circuit is connected and AC breaker is turned off.
2. Make sure the DC cable between inverter and PV string is connected, and the PV voltage is normal.
3. Turn on the DC switch, and set safety according to the local regulation.
4. Turn on the AC breaker. Check the inverter work normal.

5.6 Precaution for Initial Shutdown



- Power off the inverter before any operations and maintenance. Otherwise, shock hazard exists and the inverter may be damaged.
- Delayed discharge exists after the inverter being powered off. Wait until the equipment is totally discharged following the warning labels on the inverter.

1. Disconnect the AC switch between the inverter and the utility grid.
2. Disconnect the DC switch of the inverter.

5.7 Special Adjustable Setpoints

The inverter has a field in which the user can set functions, such as trip points, trip times, reconnect times, active and inactive QU curves and PU curves. It is adjustable through SolarGo APP. To obtain software manuals, you can download them from the official website or contact after-sales.

5.8 Voltage and frequency limits

The combination of the inverter and the automatic disconnection device can be protected in the following passive anti-islanding ways.

1. Undervoltage and overvoltage protection.
2. Under-frequency and over-frequency protection.

Refer to SolarGo User Manual for more detailed information.

Protective function	Protective function limit	Trip delay time	Maximum disconnection time
Undervoltage 2 (V < <)	70 V	1 s	2 s
Undervoltage 1 (V <)	180 V	10s	11 s
Overvoltage 1 (V >)	265 V	1 s	2 s
Overvoltage 2 (V > >)	275 V	-	0.2 s

Passive anti-islanding voltage limit values

	Region	Australia A	Australia B	Australia C	New Zealand
Under-frequency 1 (F <)	Protective function limit	47Hz	47Hz	45Hz	45Hz
	Trip delay time	1s	1s	5s	1s
	Maximum disconnection time	2s	2s	6s	2s
Over-frequency 1 (F >)	Protective function limit value	52 Hz	52 Hz	55 Hz	55 Hz
	Trip delay time	-	-	-	-
	Maximum disconnection time	0.2s	0.2s	0.2s	0.2s

Passive anti-islanding frequency limit values

5.9 Power Recovery Rate

The power recovery rate can be modified by Modbus communication, specifically according to the machine Modbus address and Modbus register value, according to the set range to set the corresponding value.

Function	The default value (Australia & New Zealand)	Setting range	Register
Power recovery rate Settings	167 (16.7%Pn/min)	50~1000	40536

If you need to change the above Settings, please contact our after-sales service.

06 Troubleshooting

In most situations, the inverter requires few maintenance. However, if the inverter is not working properly, please try the following troubleshooting solutions;
When a problem occurs, the red (fault) LED indicator on the front panel will light up and the LCD screen will display the type of the fault. The following table lists error messages and the solutions for associated faults.

Type of fault		Troubleshooting
System Failure	Isolation Failure	<ol style="list-style-type: none"> 1. Check the impedance between Ground and PV (+) & PV (-) . The impedance value must be greater than 100kΩ. Make sure the inverter is earthed. 2. Contact local service office for help if the problem still persist..
	Ground I Failure	<ol style="list-style-type: none"> 1. The ground current is too high. 2. Unplug the inputs from the PV generator and check the peripheral AC system. 3. When the problem is cleared, reconnect the PV panel and check the Inverter status. 4. Contact local service office for help if the problem still persist.
	Vac Failure	<ol style="list-style-type: none"> 1. The PV Inverter will automatically restart within 5 minutes if the grid returns to normal. 2. Make sure grid voltage conforms with the specification. 3. Make sure neutral (N) wire and PE wire are connected well. 4. Contact local service office for help if the problem still persist.
	Fac Failure	<ol style="list-style-type: none"> 1. Grid is not connected. 2. Check grid connection cables. 3. Check availability of grid.
	Utility Loss	<ol style="list-style-type: none"> 1. Not connect to the grid. 2. Check if the power grid is connected to cable. 3. Check the availability of power grid.
	PV Over Voltage	<ol style="list-style-type: none"> 1. Check if the PV open circuit voltage is higher or too close to the maximum input voltage or not. 2. If the problem still persist when PV voltage is less than the maximum input voltage, contact local service office for help.
	Over Temperature	<ol style="list-style-type: none"> 1. The internal temperature is higher than normal value specified. 2. Reduce ambient temperature. 3. Move the inverter to a cool place. 4. If the problem still exists, contact local service office for help.
Inverter Failure	Relay-Check Failure	<ol style="list-style-type: none"> 1. Turn off DC switch of the inverter. 2. Wait till the inverter's LCD light is off. 3. Turn on DC switch and make sure it is connected. 4. If the problem still exists, contact local service office for help.
	DCI Injection High	
	EEPROM R/W Failure	
	SPI Failure	
	DC BUS High	
	GFCI Failure	

Type of fault		Troubleshooting
Others	No display	<ol style="list-style-type: none"> 1. Turn off DC switch, take off DC connector, measure the voltage of PV array. 2. Plug in DC connector, and turn on DC switch. 3. If PV array voltage is lower than 250V , please check configuration of inverter module. 4. If voltage is higher than 250V , please contact local office.

Note:

When sunlight is insufficient, the PV inverter may continuously start up and shut down automatically due to insufficient power generation by the PV panels, which would not lead to inverter damage. If the problem still exists, please call the local service office.

Check Item	Method	Maintenance Period
System Cleanliness	Check the heat sink and air outlet for foreign matter and dust.	Once 6~12 months
Fan	Check the fan for normal working status, low noise, and intact appearance.	Once a year
Electrical Connections	"Check whether the cables are securely connected. Check whether the cables are broken, or whether there is any exposed copper core. "	Once 6~12 months
Sealing	Check whether all cable holes are properly sealed. Resealing the hole if it is too big or not sealed.	Once a year

08 Technical Parameters

Technical Data	GW4K-DT	GW5K-DT	GW6K-DT	GW8K-DT
Input				
Max.Input Power (W)	6000	7500	9000	12000
Max.Input Voltage (V)	1000	1000	1000	1000
MPPT Operating Voltage Range (V)	180~850	180~850	180~850	180~850
Start-up Voltage (V)	160	160	160	160
Nominal Input Voltage (V)	620	620	620	620
Max. Input Current per MPPT (A)	12.5 / 12.5	12.5 / 12.5	12.5 / 12.5	12.5 / 12.5
Max. Short Circuit Current per MPPT (A)	15.6 / 15.6	15.6 / 15.6	15.6 / 15.6	15.6 / 15.6
Number of MPPT	2	2	2	2
Number of Strings per MPPT	1	1	1	1
Output				
Nominal Output Power (W)	4000	5000	6000	8000
Max. AC Apparent Power (VA)	4400*	5500*	6600*	8800*
Nominal Output Voltage (V)	400, 3L/N/PE			
Nominal AC Grid Frequency (Hz)	50 / 60	50 / 60	50 / 60	50 / 60
Max. Output Current (A)	6.4	8	9.6	12.8
Output Power Factor	~1 (Adjustable from 0.8 leading to 0.8 lagging)			
Max. Total Harmonic Distortion	<3%	<3%	<3%	<3%
Efficiency				
Max. Efficiency	98.2%	98.2%	98.2%	98.2%
European Efficiency	>97.6%	>97.6%	>97.6%	>97.6%
Protection				
DC Insulation Resistance Detection	Integrated	Integrated	Integrated	Integrated
Residual Current Monitoring Unit	Integrated	Integrated	Integrated	Integrated
DC Reverse Polarity Protection	Integrated	Integrated	Integrated	Integrated
Anti-islanding Protection	Integrated	Integrated	Integrated	Integrated
AC Overcurrent Protection	Integrated	Integrated	Integrated	Integrated
AC Short Circuit Protection	Integrated	Integrated	Integrated	Integrated
AC Overvoltage Protection	Integrated	Integrated	Integrated	Integrated
DC Surge Arrester	Type III	Type III	Type III	Type III
AC Surge Arrester	Type III	Type III	Type III	Type III

Technical Data	GW4K-DT	GW5K-DT	GW6K-DT	GW8K-DT
DC Arc Fault Circuit Interrupter	Optional	Optional	Optional	Optional
General Data				
Operating Temperature Range (°C)	- 30~60	- 30~60	- 30~60	- 30~60
Relative Humidity	0~100%	0~100%	0~100%	0~100%
Max. Operating Altitude (m)	≤ 4000	≤ 4000	≤ 4000	≤ 4000
Cooling Method	Natural Convection	Natural Convection	Natural Convection	Smart Fan Cooling
Display	LED+LCD/WiFi+APP			
Communication	WiFi / LAN /RS485			
Weight (Kg)	15	15	15	16
Dimension (W* H*Dmm)	354*433* 147			354* 433* 155
Topology	Transformerless			
Night Power Consumption (W)	<1	<1	<1	<1
Ingress Protection Rating	IP65	IP65	IP65	IP65

*1:For Belgium Max.Output Apparent Power (VA): GW4K-DT is 4000; GW5K-DT is 5000; GW6K-DT is 6000;GW8K-DT is 8000.

Technical Data	GW10KT-DT	GW12KT-DT	GW15KT-DT
Input			
Max.Input Power (W)	15000	18000	22500
Max.Input Voltage (V)	1000	1000	1000
MPPT Operating Voltage Range (V)	180~850	180~850	180~850
Start-up Voltage (V)	160	160	160
Nominal Input Voltage (V)	620	620	620
Max. Input Current per MPPT (A)	12.5 / 12.5	12.5 / 25	12.5 / 25
Max. Short Circuit Current per MPPT (A)	15.6 / 15.6	15.6 / 31.2	15.6 / 31.2
Number of MPPT	2	2	2
Number of Strings per MPPT	1	1/2	1/2
Output			
Nominal Output Power (W)	10000	12000	15000
Max. AC Apparent Power (VA)	11000*	14000*	16500*
Nominal Output Voltage (V)	400, 3L/N/PE		
Nominal AC Grid Frequency (Hz)	50 / 60	50 / 60	50 / 60
Max. Output Current (A)	16	20.3	24
Output Power Factor	~1 (Adjustable from 0.8 leading to 0.8 lagging)		
Max. Total Harmonic Distortion	<3%	<3%	<3%
Efficiency			
Max. Efficiency	98.3%	98.3%	98.3%
European Efficiency	>97.7%	>97.7%	>97.7%
Protection			
DC Insulation Resistance Detection	Integrated	Integrated	Integrated
Residual Current Monitoring Unit	Integrated	Integrated	Integrated
DC Reverse Polarity Protection	Integrated	Integrated	Integrated
Anti-islanding Protection	Integrated	Integrated	Integrated
AC Overcurrent Protection	Integrated	Integrated	Integrated
AC Short Circuit Protection	Integrated	Integrated	Integrated
AC Overvoltage Protection	Integrated	Integrated	Integrated
DC Surge Arrester	Type III	Type III	Type III
AC Surge Arrester	Type III	Type III	Type III

Technical Data	GW10KT-DT	GW12KT-DT	GW15KT-DT
DC Arc Fault Circuit Interrupter	Optional	Optional	Optional
General Data			
Operating Temperature Range (°C)	- 30~60	- 30~60	- 30~60
Relative Humidity	0~100%	0~100%	0~100%
Max. Operating Altitude (m)	≤ 4000	≤ 4000	≤ 4000
Cooling Method	Smart Fan Cooling		
Display	LED+LCD/WiFi+APP		
Communication	WiFi / LAN /RS485		
Weight (Kg)	16	18	18
Dimension (W* H*Dmm)	354* 433* 155		
Topology	Transformerless		
Night Power Consumption (W)	<1	<1	<1
Ingress Protection Rating	IP65	IP65	IP65

*1:For Belgium Max.Output Apparent Power (VA):GW10KT-DT is 10000; GW12KT-DT is 12000; GW15KT-DT is 15000.

Technical Data	GW17KT-DT	GW20KT-DT	GW25KT-DT
Input			
Max.Input Power (W)	22500	30000	37500
Max.Input Voltage (V)	1100	1100	1100
MPPT Operating Voltage Range (V)	200~950	200~950	200~950
Start-up Voltage (V)	180	180	180
Nominal Input Voltage (V)	620	620	620
Max. Input Current per MPPT (A)	25/25	25/25	37.5/25
Max. Short Circuit Current per MPPT (A)	31.2/31.2	31.2/31.2	46.8/31.2
Number of MPPT	2	2	2
Number of Strings per MPPT	2	2	3/2
Output			
Nominal Output Power (W)	17000	20000	25000
Max. AC Apparent Power (VA)	19000*	22000*	27500*
Nominal Output Voltage (V)	400, 3L/N/PE		
Nominal AC Grid Frequency (Hz)	50 / 60	50 / 60	50 / 60
Max. Output Current (A)	28	31.9	40.8
Output Power Factor	~1 (Adjustable from 0.8 leading to 0.8 lagging)		
Max. Total Harmonic Distortion	<3%	<3%	<3%
Efficiency			
Max. Efficiency	98.4%	98.4%	98.4%
European Efficiency	>97.7%	>97.7%	>97.7%
Protection			
DC Insulation Resistance Detection	Integrated	Integrated	Integrated
Residual Current Monitoring Unit	Integrated	Integrated	Integrated
DC Reverse Polarity Protection	Integrated	Integrated	Integrated
Anti-islanding Protection	Integrated	Integrated	Integrated
AC Overcurrent Protection	Integrated	Integrated	Integrated
AC Short Circuit Protection	Integrated	Integrated	Integrated
AC Overvoltage Protection	Integrated	Integrated	Integrated
DC Surge Arrester	Type III (Type II Optional)		
AC Surge Arrester	Type III	Type III	Type III

Technical Data	GW17KT-DT	GW20KT-DT	GW25KT-DT
DC Arc Fault Circuit Interrupter	Optional	Optional	Optional
General Data			
Operating Temperature Range (°C)	- 30~60	- 30~60	- 30~60
Relative Humidity	0~100%	0~100%	0~100%
Max. Operating Altitude (m)	≤ 4000	≤ 4000	≤ 4000
Cooling Method	Smart Fan Cooling		
Display	LED+LCD/WiFi+APP		
Communication	WiFi / LAN / RS485		
Weight (Kg)	25	25	25
Dimension (W* H*Dmm)	415* 511*175		
Topology	Transformerless		
Night Power Consumption (W)	<1	<1	<1
Ingress Protection Rating	IP65	IP65	IP65

*1:For Belgium Max.Output Apparent Power (VA): GW17KT-DT is 17000; GW20KT-DT is 20000; GW25KT-DT is 25000.

Technical Data	GW8KAU-DT	GW10KAU-DT	GW15KAU-DT	GW20KAU-DT
Input				
Max.Input Power (W)	12000	15000	22500	30000
Max.Input Voltage (V)	1100	1100	1100	1100
MPPT Operating Voltage Range (V)	140~950	140~950	140~950	140~950
Start-up Voltage (V)	180	180	180	180
Nominal Input Voltage (V)	620	620	620	620
Max. Input Current per MPPT (A)	30 / 30	30 / 30	30 / 30	30 / 30
Max. Short Circuit Current per MPPT (A)	37.5 / 37.5	37.5 / 37.5	37.5 / 37.5	37.5 / 37.5
Number of MPPT	2	2	2	2
Number of Strings per MPPT	2	2	2	2
Output				
Nominal Output Power (W)	8000	10000	15000	20000
Max. AC Apparent Power (VA)	8800*	11000*	16500*	22000*
Nominal Output Voltage (V)	400, 3L/N/PE			
Nominal AC Grid Frequency (Hz)	50	50	50	50
Max. Output Current (A)	12.8	16	24	31.9
Output Power Factor	~1 (Adjustable from 0.8 leading to 0.8 lagging)			
Max. Total Harmonic Distortion	<3%	<3%	<3%	<3%
Efficiency				
Max. Efficiency	98.4%	98.4%	98.4%	98.4%
European Efficiency	>97.5%	>97.5%	>97.5%	>97.5%
Protection				
DC Insulation Resistance Detection	Integrated	Integrated	Integrated	Integrated
Residual Current Monitoring Unit	Integrated	Integrated	Integrated	Integrated
DC Reverse Polarity Protection	Integrated	Integrated	Integrated	Integrated
Anti-islanding Protection	Integrated	Integrated	Integrated	Integrated
AC Overcurrent Protection	Integrated	Integrated	Integrated	Integrated
AC Short Circuit Protection	Integrated	Integrated	Integrated	Integrated
AC Overvoltage Protection	Integrated	Integrated	Integrated	Integrated

Technical Data	GW8KAU-DT	GW10KAU-DT	GW15KAU-DT	GW20KAU-DT
DC Surge Arrester	Type II	Type II	Type II	Type II
AC Surge Arrester	Type III	Type III	Type III	Type III
DC Arc Fault Circuit Interrupter	Optional	Optional	Optional	Optional
General Data				
Operating Temperature Range (°C)	- 30~60	- 30~60	- 30~60	- 30~60
Relative Humidity	0~100%	0~100%	0~100%	0~100%
Max. Operating Altitude (m)	≤ 4000	≤ 4000	≤ 4000	≤ 4000
Cooling Method	Natural Convection		Smart Fan Cooling	
Display	LED+LCD/WiFi+APP/Bluetooth+APP			
Communication	WiFi / LAN /RS485			
Weight (Kg)	20.5	20.5	26	26
Dimension (W* H*Dmm)	415* 511* 175			
Topology	Transformerless			
Night Power Consumption (W)	<1	<1	<1	<1
Ingress Protection Rating	IP65	IP65	IP65	IP65

Note:

Overvoltage Category Definition

Category I: applies to equipment connected to a circuit where measures have been taken to reduce transient overvoltage to a low level.

Category II: applies to equipment not permanently connected to the installation. For example, appliances, portable tools and other plug-connected equipment;

Category III: applies to fixed downstream equipment, including the main distribution board. For example, switchgear and other equipment in an industrial installation;

Category IV: applies to equipment permanently connected at the origin of an installation (upstream of the main distribution board). For example, electricity meters, primary overcurrent protection equipment and other equipment connected directly to outdoor open lines.

Moisture Location Category Definition

	Level		
Moisture parameters	3K3	4K2	4K4H
Temperature Range	0~+40°C	-33~+40°C	-20~+55°C
Humidity Range	5%~85%	15%~100%	4%~100%

Environment Category Definition

Outdoor : the ambient air temperature is -20~50°C. Relative humidity range is from 4% to 100%, applied to PD3.

Indoor unconditioned: the ambient air temperature is -20~50 °C. Relative humidity range is from 5% to 95%, applied to PD3.

Indoor conditioned: the ambient air temperature is 0~40 °C. Relative humidity range is from 5% to 85%, applied to PD2.

Pollution Degree Definition

Pollution degree 1: No pollution or only dry, non-conductive pollution occurs. The pollution has no influence.

Pollution degree 2: Normally only non-conductive pollution occurs. However, a temporary conductivity occasionally caused by condensation must be expected.

Pollution degree 3: Conductive pollution occurs. Or dry, non-conductive pollution becomes conductive due to condensation, which is expected.

Pollution degree 4: Persistent conductive pollution occurs. For example, the pollution cause by conductive dust, rain and snow.



SolarGo App



SEMS Portal App



LinkedIn



Official Website

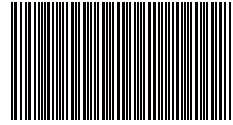

340-00505-00

GOODWE (Germany)

Fürstenrieder Str. 279a 81377 München, Germany
T: +49 8974120210 +49 421 83570-170 (service)
sales.de@goodwe.com
service.de@goodwe.com

GOODWE (Netherlands)

Franciscusdreef 42C, 3565AC Utrecht, the Netherlands
T: +31 (0) 30 737 1140
sales@goodwe.com
service.nl@goodwe.com

GOODWE (India)

1202, G-Square Business Park, Sector 30A, Opp. Sanpada
Railway Stn., Vashi, Navi Mumbai- 400703
T: +91 (0) 2249746788
sales@goodwe.com / service.in@goodwe.com

GOODWE (Turbutton)

Adalet Mah. Megapol Tower K: 9 No: 110 Bayraklı - Izmir
T: +90 (232) 935 68 18
info@goodwe.com.tr
service@goodwe.com.tr

GOODWE (Mexico)

Oswaldo Sanchez Norte 3615, Col. Hidalgo, Monterrey,
Nuevo Leon, Mexico, C.P. 64290
T: +52 1 81 2871 2871
sales@goodwe.com / soporte.latam@goodwe.com

GOODWE (China)

No. 90 Zijin Rd., New District, Suzhou, 215011, China
T: +86 (0) 512 6958 2201
sales@goodwe.com (sales)
service@goodwe.com (service)

GOODWE (Brazil)

Rua Abelardo 45, Recife/PE, 52050-310
T: +55 81 991239286
sergio@goodwe.com
servico.br@goodwe.com

GOODWE (UK)

6 Dunhams Court, Dunhams Lane, Letchworth
Garden City, SG6 1WB UK
T: +44 (0) 333 358 3184
enquiries@goodwe.com.uk / service@goodwe.com.uk

GOODWE (Italy)

Via Cesare Braico 61, 72100 Brindisi, Italy
T: +39 338 879 38 81; +39 831 162 35 52
valter.pischi@goodwe.com (sales)
operazioni@topsenergy.com; goodwe@arsimp.it (service)

GOODWE (Australia)

Level 14, 380 St. Kilda Road, Melbourne,
Victoria, 3004, Australia
T: +61 (0) 3 9918 3905
sales@goodwe.com / service.au@goodwe.com

GOODWE (Korea)

8F Invest Korea Plaza, 7 Heoleung-ro
Seocho-gu Seoul Korea (06792)
T: 82 (2) 3497 1066
sales@goodwe.com / Larry.Kim@goodwe.com

Note: The information above is subject to change without prior notice, for details refer to
<https://www.goodwe.com.au/>