



## SUNNY HOME MANAGER 2.0

## Legal Provisions

The information contained in these documents is the property of SMA Solar Technology AG. No part of this document may be reproduced, stored in a retrieval system, or transmitted, in any form or by any means, be it electronic, mechanical, photographic, magnetic or otherwise, without the prior written permission of SMA Solar Technology AG. Internal reproduction used solely for the purpose of product evaluation or other proper use is allowed and does not require prior approval.

SMA Solar Technology AG makes no representations or warranties, express or implied, with respect to this documentation or any of the equipment and/or software it may describe, including (with no limitation) any implied warranties of utility, merchantability, or fitness for any particular purpose. All such representations or warranties are expressly disclaimed. Neither SMA Solar Technology AG nor its distributors or dealers shall be liable for any indirect, incidental, or consequential damages under any circumstances.

The exclusion of implied warranties may not apply in all cases under some statutes, and thus the above exclusion may not apply.

Specifications are subject to change without notice. Every attempt has been made to make this document complete, accurate and up-to-date. Readers are cautioned, however, that product improvements and field usage experience may cause SMA Solar Technology AG to make changes to these specifications without advance notice or per contract provisions. SMA Solar Technology AG shall not be responsible for any damages, including indirect, incidental or consequential damages, caused by reliance on the material presented, including, but not limited to, omissions, typographical errors, arithmetical errors or listing errors in the content material.

### SMA Warranty

You can download the current warranty conditions from the Internet at [www.SMA-Solar.com](http://www.SMA-Solar.com).

### Software Licenses

The software licenses for the installed software modules (Open Source) are contained in the Sunny Home Manager software. Upon connecting the Sunny Home Manager with a web browser, you will find the licenses at the following address: [http://###/legal\\_notices.txt](http://###/legal_notices.txt), for example [http://192.168.22.11/legal\\_notices.txt](http://192.168.22.11/legal_notices.txt). The IP address (in this example, 192.168.22.11) will be assigned by your router for the Sunny Home Manager. You will find further information on determining the IP address in your router documentation.

### Trademarks

All trademarks are recognized, even if not explicitly identified as such. Missing designations do not mean that a product or brand is not a registered trademark.

### SMA Solar Technology AG

Sonnenallee 1

34266 Niestetal

Germany

Phone +49 561 9522-0

Fax +49 561 9522 100

[www.SMA.de](http://www.SMA.de)

E-mail: [info@SMA.de](mailto:info@SMA.de)

Status: 5/31/2022

Copyright © 2022 SMA Solar Technology AG. All rights reserved.

# Table of Contents

<b>1</b>	<b>Information on this Document</b> .....	<b>8</b>
1.1	Validity .....	8
1.2	Target Group .....	8
1.3	Levels of warning messages.....	8
1.4	Symbols in the Document.....	8
1.5	Typographical Elements in the Document.....	9
1.6	Designations in the Document .....	9
1.7	Additional Information.....	9
<b>2</b>	<b>Safety</b> .....	<b>10</b>
2.1	Intended Use.....	10
2.2	IMPORTANT SAFETY INSTRUCTIONS .....	10
2.3	Cyber Security .....	12
<b>3</b>	<b>Service Description</b> .....	<b>13</b>
<b>4</b>	<b>Scope of Delivery</b> .....	<b>15</b>
<b>5</b>	<b>Product Overview</b> .....	<b>16</b>
5.1	Product Description.....	16
5.2	Symbols on the Product.....	16
5.2.1	Light-Emitting Diodes (LEDs).....	16
5.2.2	Type Label .....	17
5.3	Components for Operating the Sunny Home Manager .....	18
5.3.1	Basic Operation .....	18
5.3.2	Operation of a PV system with SMA inverters .....	18
5.3.3	Operation of a PV system with third-party inverters.....	19
5.3.4	Components for the control of loads .....	19
<b>6</b>	<b>System Structure</b> .....	<b>21</b>
6.1	System Requirements.....	21
6.2	System Topology .....	21
<b>7</b>	<b>Mounting</b> .....	<b>23</b>
7.1	Requirements for Mounting the Sunny Home Manager .....	23
7.2	Mounting the Sunny Home Manager on the Top-Hat Rail.....	23
<b>8</b>	<b>Connection</b> .....	<b>24</b>
8.1	Safety during Electrical Connection .....	24
8.2	Connecting the Voltage Supply.....	24
8.2.1	Requirements for connecting the voltage supply .....	24
8.2.2	Connecting the Voltage Supply up to 63 A.....	25
8.2.3	Connecting the Voltage Supply greater than 63 A.....	26
8.3	Establishing communication to Sunny Portal.....	27
8.3.1	Preparing for Speedwire Communication .....	27
8.3.2	Connecting the Sunny Home Manager to the Router .....	27
8.3.3	Testing the Connection to Sunny Portal .....	28
<b>9</b>	<b>Getting Started</b> .....	<b>30</b>
9.1	Creating a Sunny Home Manager System in Sunny Portal.....	30
9.2	User Interface of the Sunny Home Manager System.....	33
9.2.1	Accessing the user interface .....	33
9.2.2	Overview of the User Interface .....	33

9.2.3	Overview of Menus and Pages .....	34
9.2.4	Working with Diagrams.....	36
9.2.4.1	Setting the Display Period .....	36
9.2.4.2	Saving Diagram Data.....	37
9.2.4.3	Printing Diagram Data.....	37
9.3	Logging In and Out of Sunny Portal.....	37
<b>10</b>	<b>Configuration of the Sunny Home Manager system .....</b>	<b>38</b>
10.1	System data .....	38
10.1.1	Overview System Data .....	38
10.1.2	Changing System Data.....	38
10.1.3	Changing the System Name .....	39
10.1.4	Deleting the System.....	39
10.1.5	Entering the Nominal System Power.....	39
10.1.6	Changing or Deleting the System Image.....	40
10.2	Configuring Strings.....	40
10.3	Changing Operator Data .....	42
10.4	Configuring parameters .....	42
10.4.1	General Information about the Configuration of the Parameters .....	42
10.4.2	Entering the Feed-In Tariff and Electricity Tariff .....	42
10.4.3	Configuring Limitation of Active Power Feed-In.....	43
10.4.4	Activating or Deactivating Grid Management Services .....	45
10.4.5	Entering time period control for charging the battery-storage system .....	45
10.4.6	Entering Peak Load Shaving.....	46
10.4.7	Setting the Optimization Target .....	47
10.4.8	Entering the Amount of CO2 Avoided .....	48
10.4.9	Entering the Expected Yield.....	48
10.5	Releasing Data .....	49
<b>11</b>	<b>Device Administration.....</b>	<b>50</b>
11.1	Device Overview Tab.....	50
11.1.1	Filtering the Device Overview .....	51
11.1.2	Configuring the Device Properties.....	51
11.1.3	Changing Device Names and Description.....	51
11.1.4	Activating Data Acceptance.....	52
11.2	Overview of New Devices Tab .....	52
11.2.1	Maximum Number of Supported Devices.....	53
11.2.2	Adding or Replacing Devices.....	54
11.3	Configuring the Sunny Home Manager.....	56
11.3.1	Selecting Simple or Extended Configuration.....	56
11.3.2	Setting Automatic Updates.....	56
11.3.3	Enabling Speedwire Encryption .....	56
11.3.4	Configuring AVM FRITZ!Box Smart Home Control .....	57
11.3.5	Configuring the display of the current status .....	57
11.3.6	Setting the Edimax Smart Plug .....	58
11.3.7	Enabling System Communication Monitoring .....	58
11.3.8	Setting the Data Request Interval .....	58
11.3.9	Activating SMA Smart Home .....	59
11.3.9.1	Activating the Self-Consumption Function.....	59
11.3.9.2	Setting up Forecast-Based Battery Charging.....	60
11.3.10	Configuring the External Current Transformer.....	60
11.3.11	Changing the Meter Configuration.....	61
11.3.12	Configuring Modbus Interfaces .....	61
11.4	Adding and Configuring the Inverter .....	62
11.4.1	Adding an Inverter .....	62
11.4.2	Entering Line Conductors .....	62

11.4.3	Entering the PV Array Power .....	62
11.5	Adding a Switching Device.....	63
11.5.1	Adding a Radio-Controlled Socket .....	63
11.5.2	Adding Modbus Device .....	64
11.6	Adding direct communicating loads.....	65
11.6.1	Pairing Loads via EEBus.....	65
11.7	Replacing the Sunny Home Manager.....	66
11.7.1	Resetting the Sunny Home Manager.....	66
11.7.2	Reassigning the Sunny Home Manager to the Sunny Portal System after the Reset.....	67
11.8	Restarting the Sunny Home Manager.....	68
11.9	Deleting devices from Sunny Portal.....	68
<b>12</b>	<b>Load Control.....</b>	<b>69</b>
12.1	Background Information.....	69
12.1.1	Types of Loads .....	69
12.1.2	Communicating with Loads.....	70
12.1.3	Controlling Loads via a Time Period .....	70
12.1.4	Prioritizing Loads .....	72
12.2	Load Overview and Planning .....	72
12.3	Configuring Switching Devices .....	74
12.3.1	Safety when Configuring Switching Devices.....	74
12.3.2	Requirements for Configuring Switching Devices.....	75
12.3.3	Assigning a Load.....	75
12.3.4	Entering the Device Name.....	75
12.3.5	Configuring the Operating Mode.....	75
12.3.6	Enabling Start-up Detection for Radio-Controlled Sockets .....	76
12.4	Configuring Load Characteristics .....	77
12.4.1	Entering general information .....	78
12.4.2	Selecting the Load Type.....	79
12.4.3	Selecting Program Controllability.....	79
12.4.4	Entering the Power Consumption .....	80
12.4.5	Entering the Maximum Program Operating Time .....	80
12.4.6	Entering the Minimum Switch-On and Switch-Off Time .....	81
12.4.7	Setting the Priority of the Load.....	81
12.4.8	Assigning a Switching Device .....	81
12.4.9	Setting Measuring and Switching of the Assigned Device.....	82
12.4.10	Setting Automatic Switch-Off.....	82
12.5	Configuring the Time Period.....	83
12.6	Directly Controlling Loads .....	86
<b>13</b>	<b>Visualization of the energy management.....</b>	<b>87</b>
13.1	System selection with system list .....	87
13.2	System overview .....	88
13.3	Current Status And Forecast .....	88
13.3.1	Overview Current Status Area .....	88
13.3.2	Overview Forecast and Recommended Action Area .....	90
13.4	Energy Balance.....	91
13.5	Load Balance and Control.....	94
13.5.1	Overview load balance and control.....	94
13.5.2	Selecting the Load Display .....	98
13.6	Display of the nominal system power .....	98
13.6.1	System yield in the annual comparison .....	98
13.6.2	Nominal system power analysis .....	100
13.6.2.1	Overview analysis.....	100
13.6.2.2	Setting the Device Selection .....	102

<b>14</b>	<b>Monitoring of the Sunny Home Manager system</b>	<b>103</b>
14.1	Overview of system monitoring	103
14.1.1	Communication Monitoring	103
14.1.2	Inverter Comparison	103
14.1.3	SMA Smart Connected	104
14.1.4	System Configuration	104
14.1.5	Further PV System Monitoring Options	104
14.2	Configuring PV System Monitoring	105
14.2.1	Setting Communication Monitoring	105
14.2.2	Setting the Inverter Comparison	105
14.2.3	Activating SMA Smart Connected	106
14.2.4	Editing the System Configuration	106
14.2.5	Filter and confirm messages in the system logbook	107
14.2.6	Configuring Reports	108
<b>15</b>	<b>Presentation of the Sunny Home Manager system</b>	<b>111</b>
15.1	PV System Profile	111
15.2	Make PV system profile publicly available	111
15.3	Releasing and publishing pages	111
15.4	Specifying the System Home Page	112
<b>16</b>	<b>User Management</b>	<b>113</b>
16.1	User Groups and User Rights	113
16.2	Creating a New User	114
16.3	Deleting a User	114
16.4	Changing User Rights	115
16.5	Changing User Information	115
<b>17</b>	<b>Password Information</b>	<b>116</b>
17.1	Requirements for a Secure System Password	116
17.2	Required Passwords	116
17.3	Changing Passwords	117
17.4	Procedure in Case of Forgotten Passwords	117
<b>18</b>	<b>Troubleshooting</b>	<b>119</b>
18.1	Error message on the Sunny Home Manager	119
18.2	Problems during Registration with the System Setup Assistant	120
18.3	Problems with Integration of Devices	123
18.4	Problems with Data Update	125
18.5	Problems when Configuring and Controlling Radio-Controlled Sockets	128
18.6	Using the Sunny Home Manager Assistant in case of network problems	129
18.7	Messages in the system logbook	130
<b>19</b>	<b>Decommissioning</b>	<b>133</b>
19.1	Decommissioning the Sunny Home Manager	133
19.2	Packing the Product for Shipment	133
19.3	Disposing of the Product	133
<b>20</b>	<b>Appendix</b>	<b>134</b>
20.1	Application example forecast-based battery charging	134
20.1.1	Objective and Background Information	134
20.1.2	Setting up Forecast-Based Battery Charging	135

<b>21</b>	<b>Technical Data .....</b>	<b>137</b>
<b>22</b>	<b>Declarations of Conformity .....</b>	<b>139</b>
22.1	EU Declaration of Conformity .....	139
22.2	UK Declaration of Conformity .....	139
<b>23</b>	<b>Contact .....</b>	<b>140</b>

# 1 Information on this Document

## 1.1 Validity

This document is valid for:

- Sunny Home Manager 2.0 from software package 2.09.02.R

## 1.2 Target Group

This document is intended for qualified persons and end users. Only qualified persons are allowed to perform the activities marked in this document with a warning symbol and the caption "Qualified person". Tasks that do not require any particular qualification are not marked and can also be performed by end users. Qualified persons must have the following skills:

- Training in how to deal with the dangers and risks associated with installing, repairing and using electrical devices and installations
- Training in the installation and commissioning of electrical devices and installations
- Knowledge of all applicable laws, standards and directives
- Knowledge of and compliance with this document and all safety information

## 1.3 Levels of warning messages

The following levels of warning messages may occur when handling the product.

### DANGER

Indicates a hazardous situation which, if not avoided, will result in death or serious injury.

### WARNING

Indicates a hazardous situation which, if not avoided, could result in death or serious injury.







### CAUTION

Indicates a hazardous situation which, if not avoided, could result in minor or moderate injury.

### NOTICE

Indicates a situation which, if not avoided, can result in property damage.

## 1.4 Symbols in the Document

Icon	Explanation
	Information that is important for a specific topic or goal, but is not safety-relevant
	Indicates a requirement for meeting a specific goal
	Desired result
	A problem that might occur.
	Example
	Sections describing activities to be performed by qualified persons only



## 1.5 Typographical Elements in the Document

Typographical element	Use	Example
<b>bold</b>	<ul style="list-style-type: none"> <li>• Messages</li> <li>• Terminals</li> <li>• Elements on a user interface</li> <li>• Elements to be selected</li> <li>• Elements to be entered</li> </ul>	<ul style="list-style-type: none"> <li>• Connect the insulated conductors to the terminals <b>X703:1</b> to <b>X703:6</b>.</li> <li>• Enter <b>10</b> in the field <b>Minutes</b>.</li> </ul>
>	<ul style="list-style-type: none"> <li>• Connects several elements to be selected</li> </ul>	<ul style="list-style-type: none"> <li>• Go to <b>Settings &gt; Date</b>.</li> </ul>
[Button] [Key]	<ul style="list-style-type: none"> <li>• Button or key to be clicked on or pressed down</li> </ul>	<ul style="list-style-type: none"> <li>• Select [Enter].</li> </ul>
#	<ul style="list-style-type: none"> <li>• Placeholder for variable components (e.g., parameter names)</li> </ul>	<ul style="list-style-type: none"> <li>• Parameter <b>WClHz.Hz#</b></li> </ul>

## 1.6 Designations in the Document

Complete designation	Designation in this document
Sunny Home Manager 2.0	Sunny Home Manager, product

## 1.7 Additional Information

For more information, please go to [www.SMA-Solar.com](http://www.SMA-Solar.com).

Title and information content	Type of information
SMA SMART HOME - Compatibility list for the Sunny Home Manager 2.0	Technical Information
"SMA Smart Home" The System Solution for Greater Independence	Planning Guidelines
"SMA SMART HOME - Battery Charging Management with Time-of-Use Energy Tariffs"	Technical Information
"SMA SMART HOME Load Control Using Relays or Contactors - Example: Heating Rod"	Technical Information
SMA FLEXIBLE STORAGE SYSTEM Increased Self-Consumption with Sunny Island and Sunny Home Manager	System description
"SUNNY PORTAL powered by ennexOS"	User Manual
"PUBLIC CYBER SECURITY - Guidelines for a Secure PV System Communication"	Technical Information
User information on the operation and features of the product	User information on the Sunny Portal user interface
Answers to frequently asked questions	FAQs in Sunny Portal and at Online Service Center

## 2 Safety

### 2.1 Intended Use

The Sunny Home Manager is the central product responsible for energy management in households with a photovoltaics (PV) system and battery-storage system for self-consumption. The Sunny Home Manager continuously records the solar power generated by the PV system and, if desired, ensures optimal use of the solar power by combining all suitable energy flows in the household to create an intelligent system and, upon request, control it automatically.

The online portal Sunny Portal is used to operate and configure the Sunny Home Manager. The user can make all the required and desired settings here.

The Sunny Home Manager is not an energy meter for power consumption in the sense of the EU directive 2004/22/EG (MID). The Sunny Home Manager may not be used for billing purposes. The data collected by the Sunny Home Manager relating to the power generated by your PV system may deviate from the data of the main energy meter, which is used for billing purposes.

The Sunny Home Manager supports up to 24 devices and can actively control a maximum of 12 devices.

The Sunny Home Manager is not suitable for controlling life-sustaining medical devices. A power outage must not lead to personal injury. Loads connected to the Sunny Home Manager must have an CE, UKCA, RCM or UL identification label.

The Sunny Home Manager is approved for use in all EU member states, in Great Britain, Australia and selected other countries.

The type label must remain permanently attached to the product.

#### Environment

The product is designed for indoor use only.

The Sunny Home Manager may only be connected to the subdistribution of the household on the load side behind the energy meter of the electric utility company. The Sunny Home Manager must be installed in a switch cabinet or in a domestic installation cabinet in the area of the additional applications intended for this as per VDE-AR-N 4100:2019-04.

It is possible to use the Sunny Home Manager in delta IT grids. When using the Sunny Home Manager in delta IT grids, the cumulative power values are correctly measured. Due to the measuring principle of the Sunny Home Manager, other measured values may be incorrect.

#### Statutory warranty

Use SMA products only in accordance with the information provided in the enclosed documentation and with the locally applicable laws, regulations, standards and directives. Any other application may cause personal injury or property damage.

Alterations to the SMA products, e.g., changes or modifications, are only permitted with the express written permission of SMA Solar Technology AG. Unauthorized alterations will void guarantee and warranty claims and in most cases terminate the operating license. SMA Solar Technology AG shall not be held liable for any damage caused by such changes.

Any use of the product other than that described in the Intended Use section does not qualify as the intended use.

The enclosed documentation is an integral part of this product. Keep the documentation in a convenient, dry place for future reference and observe all instructions contained therein.

This document does not replace any regional, state, provincial, federal or national laws, regulations or standards that apply to the installation, electrical safety and use of the product. SMA Solar Technology AG assumes no responsibility for the compliance or non-compliance with such laws or codes in connection with the installation of the product.

### 2.2 IMPORTANT SAFETY INSTRUCTIONS

Keep the manual for future reference.

This section contains safety information that must be observed at all times when working.

The product has been designed and tested in accordance with international safety requirements. As with all electrical or electronical devices, there are residual risks despite careful construction. To prevent personal injury and property damage and to ensure long-term operation of the product, read this section carefully and observe all safety information at all times.

### DANGER

#### **Danger to life due to electric shock when live components or cables are touched**

High voltages are present in the conductive components or cables of the product. Touching live parts and cables results in death or lethal injuries due to electric shock.

- Disconnect the product from voltage sources and make sure it cannot be reconnected before carrying out any work on the product.
- Before carrying out any work on the product, disconnect the grid side from all voltage sources using the installed disconnect switch.
- Ensure that the conductors to be connected are de-energized.
- Clean the product with a dry cloth only.
- Only use the product in a dry environment and keep it away from moisture.
- Install the product in the switch cabinet only and ensure that the connection areas for the line conductors and the neutral conductor are behind a cover or have contact protection.
- Observe the prescribed minimum clearance between the network cable and live installation components, or use suitable insulation.

### DANGER

#### **Danger to life due to electric shock if external disconnect switch is missing**

High voltages are present in the conductive components. Touching live parts results in death or lethal injuries due to electric shock.

- Install an external disconnect switch between the product and the grid-connection point. The external disconnecter must be close to the product and easily accessible.
- Before carrying out any work on the product, disconnect the grid side from all voltage sources using the installed disconnect switch.

### DANGER

#### **Danger to life due to electric shock in case of overvoltages and if surge protection is missing**

Overvoltages (e. g. in the event of a flash of lightning) can be further conducted into the building and to other connected devices in the same network via the network cables or other data cables if there is no surge protection. Touching live parts and cables results in death or lethal injuries due to electric shock.

- Ensure that all devices in the same network are integrated in the existing overvoltage protection.

### WARNING

#### **Danger of fire due to missing or incorrect fuse**

If a fuse is missing or incorrect and a fault occurs, a fire may be caused. This can result in death or serious injury.

- Protect the line conductors of the product with a fuse or a selective circuit breaker with max. 63 A.

## NOTICE

### Manipulation of system data in networks

You can connect the supported SMA products to the Internet. When connected to the Internet, there is a risk that unauthorized users can access and manipulate the data of your system.

- Set up a firewall.
- Close unnecessary network ports.
- If absolutely necessary, only enable remote access via a virtual private network (VPN).
- Do not use the port forwarding feature. This also applies to the used Modbus ports.
- Disconnect system components from other network components (network segmentation).
- Even if the product is used as energy and grid-supply meter, the system setup assistant in Sunny Portal must be used and an administrator account created.

### **i** DHCP Server is recommended.

The DHCP server automatically assigns the appropriate network settings to your nodes in the local network. A manual network configuration is therefore not necessary. In a local network, the Internet router is usually the DHCP server. If the IP addresses in the local network are to be assigned dynamically, DHCP must be activated in the Internet router (see the Internet router manual). In order to receive the same IP address by the internet router after a restart, set the MAC address binding.

In networks where no DHCP server is active, proper IP addresses must be assigned from the free address pool of the network segment to all network participants to be integrated during commissioning.

## 2.3 Cyber Security

Most operating activities such as monitoring and control of systems can be done locally by the PV system operator or service personnel without the need for data communication via public Internet infrastructure.

In other use cases of systems, the PV systems are also part of the global communication system, which is based on Internet infrastructures.

The data communication via Internet is an up-to-date, economically viable and customer-friendly approach in order to enable easy access for the following modern applications such as:

- Cloud platforms (e.g. Sunny Portal)
- Smartphones or other mobile devices (iOS or Android apps)
- SCADA systems, which are remotely connected
- Utility interfaces for grid management services

Alternatively, selected and secured communication interfaces may be used. These solutions are no longer state of the art and are very expensive to use (special communication interfaces, separate wide area networks and more).

When using the Internet infrastructure, the systems connected to the Internet are entering a basically unsecure area. Potential attackers constantly seek vulnerable systems. Usually, they are criminally motivated, have a terrorist background or aim to disrupt business operations. Without taking any measures to protect systems and other systems from such misuse, a data communication system should not be connected to the Internet.

Communication between the SMA internet platform Sunny Portal and the Sunny Home Manager takes place via the Webconnect process as well as the HTTPS protocol, i.e. an authenticated and encrypted connection and thus allows safe online communication.

You can find the current recommendations by SMA Solar Technology AG on the topic of Cyber Security in the Technical Information "PUBLIC CYBER SECURITY - Guidelines for a Secure PV System Communication" at [www.SMA-Solar.com](http://www.SMA-Solar.com).

## 3 Service Description

The field of applications for the Sunny Home Manager ranges from its use as a simple energy meter to monitoring a PV system and intelligent energy management.

### Sunny Home Manager as energy meter

The Sunny Home Manager detects energy flows in both directions:

- Continuous recording of the energy generated by the PV system
- Measurement of the feed-in of generated energy into the utility grid as well as the consumption of energy from the utility grid takes place at the point of interconnection.

### Sunny Home Manager in systems without self-consumption

#### Monitoring

Basic PV system status monitoring to confirm correct system performance:

All energy flows are recorded and evaluated. You will be notified about disturbances at an early stage.

#### Limitation of Active Power Feed-In

Local legal regulations, for example the Renewable Energy Sources Act (EEG) in Germany, can call for permanent limitation of active power feed-in for your PV system - that is, a limitation of the active power fed into the utility grid to a fixed amount or a percentage share of the installed nominal PV system power.

The Sunny Home Manager monitors the active power that is fed into the utility grid. If the active power feed-in exceeds the prescribed threshold, the Sunny Home Manager will limit the PV generation of the PV and hybrid inverters.

### Sunny Home Manager in systems with self-consumption

Self-consumption means that the energy produced by your PV system is consumed at the site where it is generated. Self-consumption reduces the amount of energy that you feed into the utility grid, but also the amount of energy that you purchase from your grid operator.

#### Energy Management - Monitoring and Forecast

Creation of a PV generation forecast - based on the location-based weather forecast

Creation of a load profile - based on individual analysis of time-dependent energy consumption:

Taking into account different electricity prices, the Sunny Home Manager makes recommendations for the prudent use of electrical energy. This allows you to selectively switch on loads at times when electricity is cheap (loads include, for example, home appliances such as dishwashers, dryers, washing machines, as well as heating and hot water preparation via heat pumps, and heating elements, but also charging stations for e-mobility).

To learn the load profile, the consumption data should be available over a period of at least 2 weeks.

The forecast generated by the Sunny Home Manager is calculated from the estimated energy balance from generation and consumption for the next 48 hours.

#### Optimized self-consumption through load control

The Sunny Home Manager measures the power consumption of all connected loads and records both the power consumption and the usage time of a load. The Sunny Home Manager uses this individual load profile combined with the location-based weather forecast to support your increased self-consumption:

To control loads, there are the following options:

- Control of loads that do not communicate directly via switching devices such as radio-controlled sockets or relays, e.g. Modbus devices that control the SG Ready interface of loads
- Control of directly communicating loads via the standard protocol interfaces EEBus or SEMP

The Sunny Home Manager switches home appliances on automatically when PV energy is available.

**Optimized self-consumption through dynamic active power limitation**

- Through forecast-based load control, the Sunny Home Manager ensures that even on sunny days excess energy hardly ever gets lost that has to be "curtailed" due to the limitation of the active power.
- When using SMA battery inverters, the Sunny Home Manager prevents derating losses that can be caused by limiting the active power feed-in. Taking the PV generation forecast and the consumption forecast into account, the time and duration of battery charging are chosen so that the battery is charged when PV energy is available.

**Increased self-consumption through forecast-based battery charging**

The Sunny Home Manager increases the efficiency of your PV system by storing the excess energy generated during the midday peak, which is not allowed to be fed into the utility grid due to the active power limitation, in batteries. By means of the location-based weather forecast, the Sunny Home Manager can predict the solar irradiation for some hours to days and check whether derating losses due to the limitation of PV grid feed-in are to be expected for the current or following day. This means that in the afternoon of the current day only as much PV energy is charged to the battery as to ensure that, with the remaining battery charge, grid-supplied power at night and on the morning of the next day can be avoided. Any derating losses forecast for the following day are avoided by the free storage capacity of the more heavily discharged battery.

**Increased self-consumption through peak load shaving**

In systems with SMA battery or hybrid inverters, the self-consumption portion can be additionally increased and more electricity costs saved by virtually distributing the total storage capacity of the battery between increased self-consumption and peak load shaving (multi-use). In doing so, the battery can be integrated even more flexibly into your energy management

- Increased self-consumption - through flexible use of the self-generated solar power stored in the battery at times when insufficient or no solar power is produced
- Peak load shaving - limitation of power consumption from the utility grid; any increased energy demand at certain times is drawn from the battery

## 4 Scope of Delivery

Check the scope of delivery for completeness and any externally visible damage. Contact your distributor if the scope of delivery is incomplete or damaged.

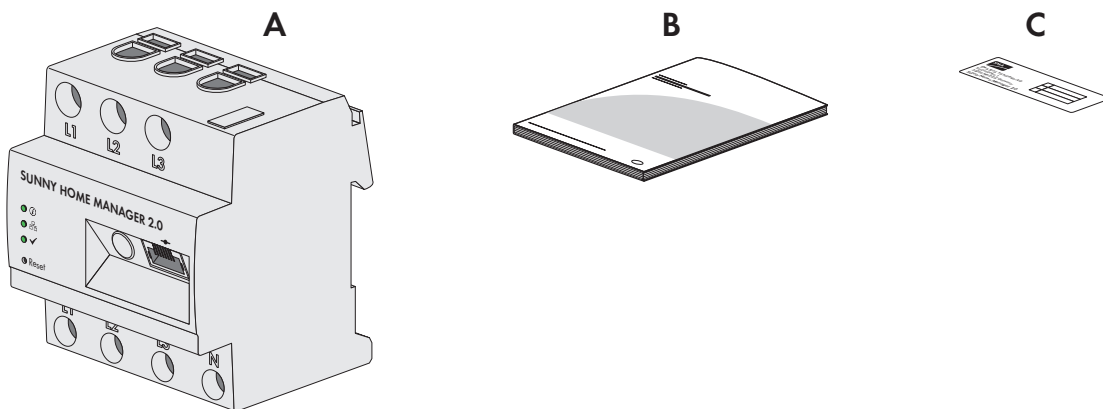

Figure 1: Components included in scope of delivery

Position	Quantity	Designation
A	1	Sunny Home Manager
B	1	Quick reference guide for commissioning
C	1	Label with serial number (SN), registration ID (RID) and identification key (PIC) for registration of the device by means of the setup assistant in the Sunny Portal

## 5 Product Overview

### 5.1 Product Description

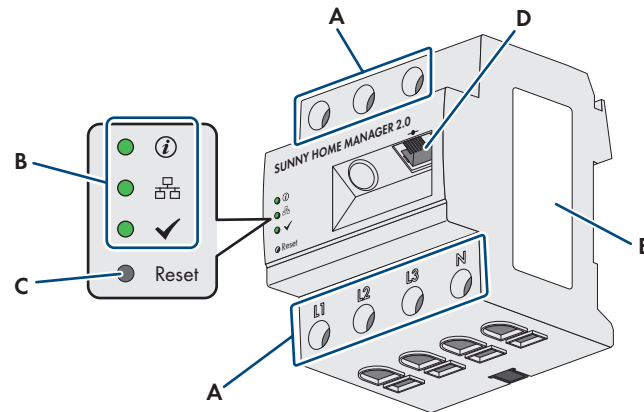

Figure 2: Sunny Home Manager 2.0

Position	Designation
A	Connection area for line conductors and neutral conductor
B	Light-emitting diodes
C	Reset button
D	Network terminal (Speedwire/Ethernet)
E	Type label

### 5.2 Symbols on the Product

#### 5.2.1 Light-Emitting Diodes (LEDs)

The LEDs indicate the operating state of the product.

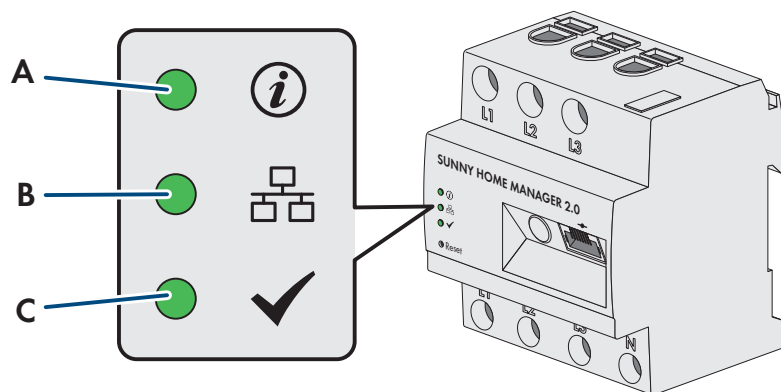



Figure 3: LEDs of the Sunny Home Manager

Position	LED symbol	Designation	Explanation
A		Status LED	Displays the operating state of the Sunny Home Manager (operation, startup process, error status)



Position	LED symbol	Designation	Explanation
B		COM LED	Displays the status of the Ethernet connection to the router
C		Performance LED	Displays the operating state, energy management, portal connection and error status.

### Sunny Home Manager operating states

LED	Status	Explanation
Status LED	glowing green	Sunny Home Manager is switched on.
	flashing green	The firmware is being updated.
	glowing red	Sunny Home Manager is starting.
	flashing red	No connection to Sunny Portal.
COM LED	Off	No Ethernet connection.
	glowing green	Ethernet connection is established.
	flashing green	Sunny Home Manager is sending or receiving data.
Performance LED	Off	Sunny Home Manager is not registered in Sunny Portal.
	glowing green	Energy management in Sunny Home Manager is running smoothly.
	flashing green	
	glowing red	An error has occurred. The error has already been reported to Sunny Portal.
	flashing red	An error has occurred. The error has not yet been reported to Sunny Portal.
		No connection to Sunny Portal.

## 5.2.2 Type Label







### Data on the Type Label

The type label clearly identifies the product. The type label is located on the side of the product and must remain permanently attached to the product. You will find the following information on the type label:

- Assembly name
- Hardware version (Version)
- Serial number (SN)
- Registration ID (RID)
- Identification key (PIC)
- MAC address (MAC)

You will require the information on the type label to use the product safely and when seeking customer support from Service (see Section 23, page 140).

## Symbols on the type label

Icon	Explanation
	WEEE designation Do not dispose of the product together with the household waste but in accordance with the disposal regulations for electronic waste applicable at the installation site.
	Protection class II The product has a reinforced or double insulation between grid current circuit and output voltage.
	Qualified person The product may only be installed by a qualified person.
	CE marking The product complies with the requirements of the applicable EU directives.
	UKCA marking The product complies with the regulations of the applicable laws of England, Wales and Scotland.
	RCM (Regulatory Compliance Mark) The product complies with the requirements of the applicable Australian standards.
	Data matrix code 2D code for device-specific characteristics

## 5.3 Components for Operating the Sunny Home Manager

### 5.3.1 Basic Operation

The following components are required for operating the Sunny Home Manager:

- Internet access via router (for Sunny Portal connection)
- PC with web browser
- Sunny Portal access

#### Router

The Sunny Home Manager establishes the internet connection to Sunny Portal via a router.

Via the Ethernet connection of the Sunny Home Manager to the router, the data read out by the integrated measuring device of the Sunny Home Manager from all devices integrated in the system is sent to the Sunny Portal. The user can make all the required settings for the Sunny Home Manager system via Sunny Portal.

#### Sunny Portal

Sunny Portal is an Internet portal which enables you to monitor and configure systems and to visualize system data. The Sunny Portal system setup assistant is used to commission the Sunny Home Manager (to [www.sunnyportal.com/register](http://www.sunnyportal.com/register))

### 5.3.2 Operation of a PV system with SMA inverters

The Sunny Home Manager organizes the electricity generated by the PV system and provided by inverters within the loads in the household. The Sunny Home Manager regulates the feed-in of the residual current into the utility grid at the point of interconnection.

Inverters can communicate in two different ways with the Sunny Home Manager:

- **Wired via SMA Speedwire/Ethernet**  
The inverter must be connected to the local network via a network cable (e.g. via a router).
- **Wireless via SMA Speedwire/Wi-Fi**  
The Sunny Home Manager does not have its own a Wi-Fi connection, however it can communicate with all devices connected to the same router.

The Sunny Home Manager supports all inverters with integrated or retrofitted Speedwire interface of SMA Solar Technology AG. The inverters must have the current firmware version in each case (see the inverter product page at [www.SMA-Solar.com](http://www.SMA-Solar.com)).

### 5.3.3 Operation of a PV system with third-party inverters

For the operation of the Sunny Home Manager in a system with third-party inverters, an SMA Energy Meter as a PV generation meter is required.

- The power output of the inverters from other manufacturers must be captured via a separate SMA Energy Meter.
- The SMA Energy Meter must be configured in Sunny Portal as a PV generation meter.

If third-party inverters are also used in the PV system, the SMA Energy Meter handles the recording of the generated PV energy. In hybrid systems with SMA inverters and inverters from other manufacturers, the generated energy of all inverters is measured via the energy meter since it is used as the central PV generation meter. Upon registering and configuring a PV generation meter in the Sunny Home Manager system, the Sunny Home Manager will receive the power data of the SMA inverters on this PV generation meter.

Monitoring of the PV system and the dynamic limitation of the active power fed into the utility grid are not possible with inverters from other manufacturers. In this case, verify whether operation of the PV system without dynamic active power limitation is permitted in the given country, or whether dynamic active power limitation can be performed independently by the inverter itself.

### 5.3.4 Components for the control of loads

At least one of the following compatible components must be present to control loads:

- Switching device, e.g. a radio-controlled socket, a relay or a Modbus device
- Device with EEBus or SEMP interface

#### Switching device

Devices that do not have a directly communicating data connection can be integrated into the energy management system as an intermediate switch via radio-controlled sockets, relays or Modbus devices. The Sunny Home Manager controls the switching device; the switching device can then switch the loads on and off via control signals from the Sunny Home Manager. For example, the Modbus device Moxa E1214 offers the possibility to control a heat pump via the relay output R0 (terminal 9 and 10).

At which times the Sunny Home Manager switches the switching device on or off automatically and without any further manual operation depends on the configuration of the load and the current load planning configured in the Sunny Portal: The Sunny Home Manager can measure the power consumption and length of the power consumption of individual loads connected to a switching device and transmits these measured values to Sunny Portal. There, you can control specific loads so that they are switched on if a lot of PV power is available, for example.

In addition, switching devices can be used purely for monitoring purposes, i.e. to measure the energy consumption of individual loads.

#### Device with EEBus or SEMP interface

To control a load that communicates directly, this load must have an EEBus or SEMP interface that is compatible with the Sunny Home Manager.

Links to additional information can be found at [www.SMA-Solar.com](http://www.SMA-Solar.com).

 SMA offers the option to use the protocol interface SEMP under <https://www.sma.de/produkte/sma-developer.html>.

## 6 System Structure

### 6.1 System Requirements

#### Router

The router connects the Sunny Home Manager via the Internet to Sunny Portal.

SMA recommends a permanent Internet connection (flat rate) and the use of a router that supports the dynamic assignment of IP addresses (DHCP – Dynamic Host Configuration Protocol), e.g. a Fritz!Box.

All network components used must support the IGMP protocol, minimum version 3 (IGMPv3). If Ethernet network switches are used in the system, make sure that they do not perform "IGMP snooping". This is the case with most simple switches; this function must be turned off for higher-quality "managed" network switches. Using media couplers such as powerline adaptors can cause transmission problems. Usually, a firmware update of the manufacturer makes these devices compatible with multicast operation.

#### Supported web browsers

The Sunny Home Manager uses the Sunny Portal as an operating and visualization surface. Sunny Portal supports all major web browsers.

#### Recommended display resolution of PCs connected to Sunny Portal

- Minimum 1024 pixels x 768 pixels

### 6.2 System Topology

The Sunny Home Manager must be installed behind the meter and the input fuse of the grid operator and in front of the first distributor in the house. SMA recommends using the Sunny Home Manager for measuring at the point of interconnection. As a bidirectional device, the Sunny Home Manager measures both the grid-supplied power and the grid feed-in at the point of interconnection. For the function **Limiting of the active power feed-in**, at least one measurement at the point of interconnection is required.

The Sunny Home Manager receives the measured data for PV generation, grid feed-in, and grid-supplied power via the integrated measuring device directly from the connected SMA inverters or a separate, optionally connected SMA Energy Meter.

If third-party inverters are installed in the system, an energy meter must measure the PV generation of all inverters. The Sunny Home Manager adopts the data and processes it.

**Operation of the PV system with SMA inverters or with optional third-party inverters by using an SMA Energy Meter**

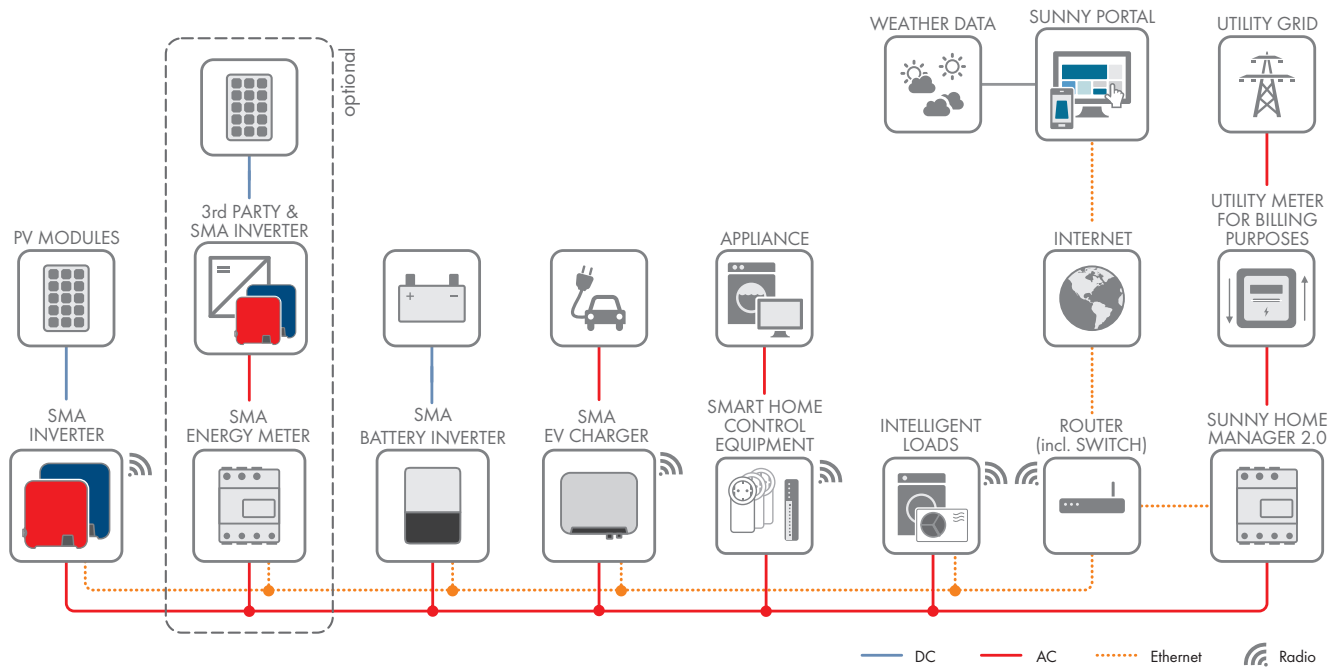

Figure 4: Topology showing SMA storage solutions and various controlled loads (general example)

## 7 Mounting

### 7.1 Requirements for Mounting the Sunny Home Manager

- The mounting location must be indoors.
- The Sunny Home Manager must be installed in a switch cabinet.  
The short-circuit current (circuit distributor or subdistributor) must not exceed 6 kA.
- The mounting location must be protected against dust, moisture and corrosive substances.
- The cable route from the mounting location to the router must not exceed a maximum length of 100 m.
- A minimum distance of 1 m must be maintained from devices using the 2.4 GHz radio spectrum (e.g. WLAN devices, microwave ovens). This will prevent reduced connection quality and data transmission speed.
- The ambient conditions at the mounting location must be suitable for the operation of the Sunny Home Manager (see Section 21, page 137).

### 7.2 Mounting the Sunny Home Manager on the Top-Hat Rail

#### Requirement:

- The top-hat rail must be securely mounted in the switch cabinet.

#### Procedure:

1. Press the Sunny Home Manager with the upper retainers into the upper edge of the top-hat rail.

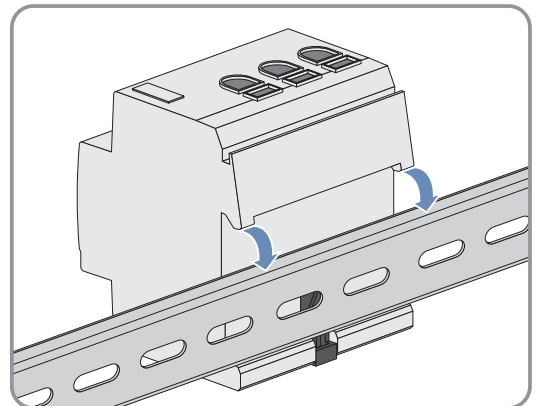

2. Hook the lower retainers into the lower edge of the top-hat rail.

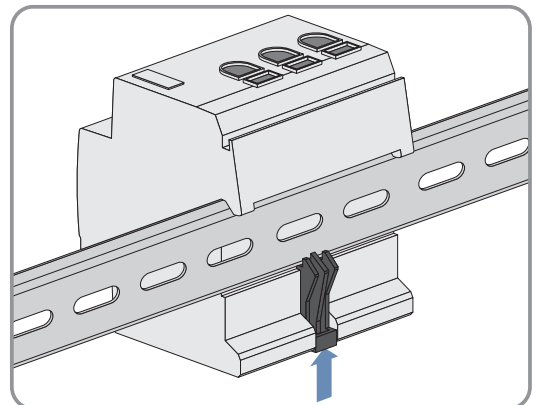

## 8 Connection

### 8.1 Safety during Electrical Connection

#### **⚠ WARNING**

##### **Risk of fire due to dirty or oxidized contact surfaces of live aluminum conductors**

Connecting dirty or oxidized contact surfaces with aluminum conductors reduces the ampacity of the live terminals, thereby increasing the transition resistances. This can cause components to overheat and catch fire.

- The contact surfaces are to be cleaned, brushed, and treated with acidic and alkaline substances (e.g. petroleum jelly or special thermal grease).

### 8.2 Connecting the Voltage Supply

#### 8.2.1 Requirements for connecting the voltage supply

##### **Requirements:**

- The setpoints of the electric utility company must be observed.
- The product can be operated single-phase or three-phase. Since the product is supplied with electric current by the screw terminal L1, at least the line conductor L1 and the neutral conductor N must be connected in order that the Sunny Home Manager switches on.
- When using fine stranded conductors, bootlace ferrules must be used.

##### **Cable requirements:**

- Conductor cross-section for measurements up to 63 A: 10 mm<sup>2</sup> to 25 mm<sup>2</sup>
- Conductor cross-section with current transformer: at least 1.5 mm<sup>2</sup>, for more information see recommendations of the current transformer manufacturer



## 8.2.2 Connecting the Voltage Supply up to 63 A

### 3 phase TN/TT

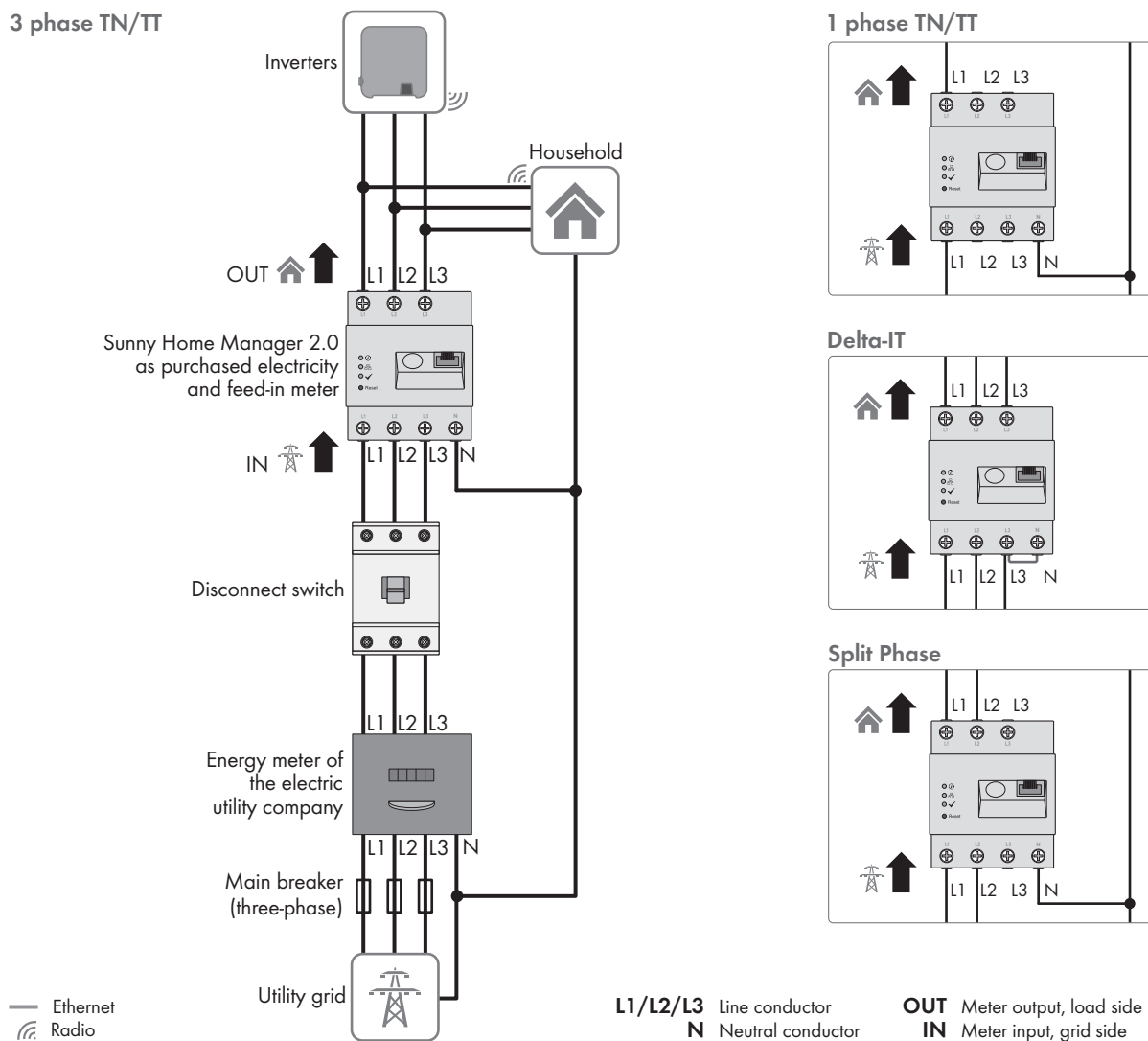

### 1 phase TN/TT

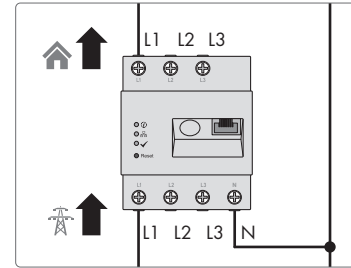

### Delta-IT

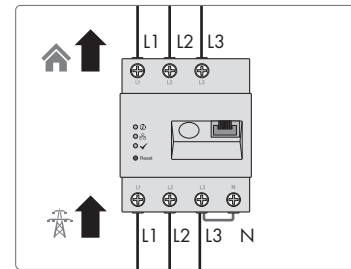

### Split Phase

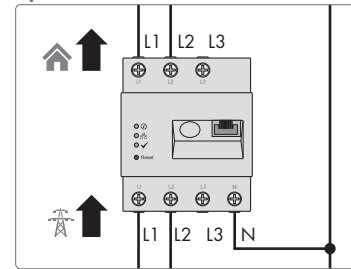

Figure 5: The following figure shows a connection example in TN and TT utility grids in the case of installation at the grid-connection point when using the integrated measuring unit.

### Procedure:

1. Disconnect the connection point from voltage sources and make sure it cannot be reconnected.
2. Connect the line conductors depending on the utility grid conditions to the Sunny Home Manager as follows:
  - in **Three-phase utility grids** connect the line conductors L1, L2, L3 and the neutral conductor N to the screw terminals at the input of the Sunny Home Manager.
  - in **Single-phase utility grids** connect the line conductor L1 and the neutral conductor N to the screw terminals at the input of the Sunny Home Manager.
  - in **Delta IT utility grids** connect the line conductors L1, L2 and L3 to the screw terminals at the input of the Sunny Home Manager. In addition, also connect the line conductor L3 to the neutral conductor N.
  - in **Split phase grids** (split-phase system) connect the line conductors L1 and L2 and the neutral conductor N to the screw terminals at the input of the Sunny Home Manager.
 Open each screw terminal using a cross-head screwdriver, insert the conductor into the contact terminal and tighten the screw (torque: 2.0 Nm).

If you do not want to use the Sunny Home Manager - as provided by default - as a bi-directional device, but should opt for only one of its two functions, the Sunny Home Manager must be connected as follows:

- When only using it to measure the PV generation power:  
Connect the Sunny Home Manager to the common connection point of all PV inverters in the household grid.  
Information: To measure the grid exchange capacity, an SMA Energy Meter must be installed at the point of interconnection.
- When only using it to measure the grid exchange capacity:  
connect the line conductor L1 and the neutral conductor to the screw terminals at the input of the Sunny Home Manager. Open each screw terminal using a cross-head screwdriver, insert the conductor into the contact terminal and tighten the screw (torque: 2.0 Nm).

### 8.2.3 Connecting the Voltage Supply greater than 63 A

Current transformers must be installed for a voltage supply > 63 A.

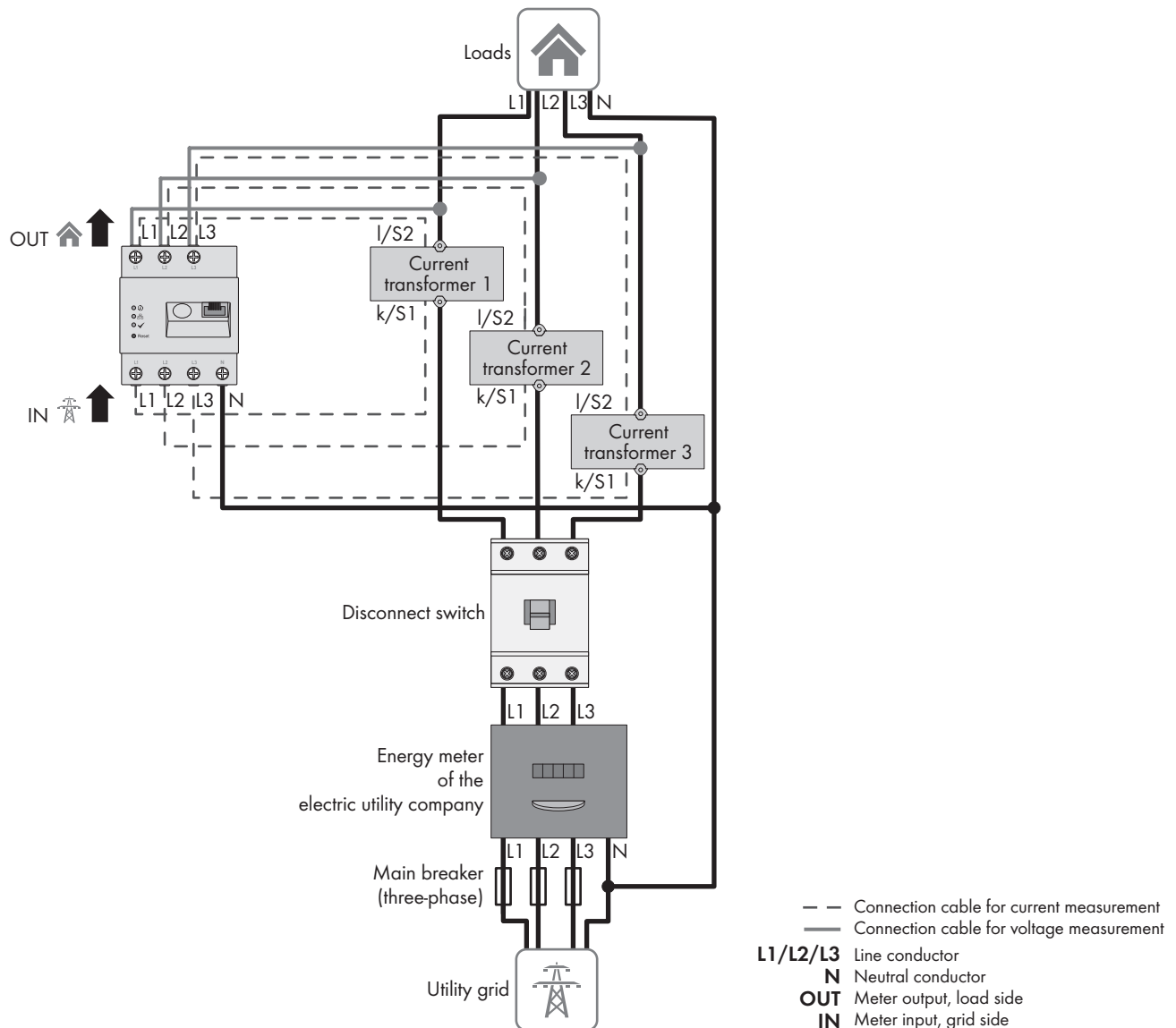

Figure 6: The following figure shows a connection example in TN and TT utility grids in the case of installation at the grid-connection point.

#### Additionally required material (not included in the scope of delivery):

- 3 x current transformer (recommendation: 5 A secondary current, accuracy class at least 1)
- Connection cables for current transformers

#### Procedure:

1. Disconnect the connection point from voltage sources and make sure it cannot be reconnected.

2. Connect one current transformer to each line conductor L1, L2 and L3.
3. On each current transformer, connect 1 connection cable for secondary current measurement to terminals k/S1 and l/S2.
4. Connect the connection cables for current measurement (dashed gray line) to the screw terminals L1, L2 and L3 of the Sunny Home Manager. To do this, open each screw terminal using a cross-head screwdriver, insert the conductor into the contact terminal and tighten the screw using a cross-head screwdriver (torque: 2.0 Nm).
5. Connect the connection cables for voltage measurement (solid gray line) to the screw terminals L1, L2 and L3 at the output of the Sunny Home Manager. To do this, open each screw terminal using a cross-head screwdriver, insert the conductor into the contact terminal and tighten the screw using a cross-head screwdriver (torque: 2.0 Nm).
6. Connect the connection cables for voltage measurement L1, L2 and L3 (solid gray line) to the corresponding line conductors L1, L2 and L3.

## 8.3 Establishing communication to Sunny Portal

### 8.3.1 Preparing for Speedwire Communication

If the Sunny Home Manager is to communicate with other SMA devices via SMA Speedwire (Ethernet), the Sunny Home Manager and the Speedwire devices must be in the same local network.

#### **i** Inverters with Webconnect function

If an inverter is already registered in Sunny Portal with the Webconnect function, the inverter cannot be added to the Sunny Home Manager system in Sunny Portal.

- In order to be able to add the inverter to the Sunny Home Manager system in Sunny Portal, delete the inverter with Webconnect function from the Webconnect system in Sunny Portal or deactivate data reception for the inverter in the Webconnect system in Sunny Portal.

#### Requirements:

- DHCP must be active on the router (see router documentation).
- All UDP ports > 1024 on the router must be open for outgoing connections. If there is a firewall installed on the router, you might have to adjust the firewall settings.
- It must be possible for the outgoing router connections to reach all Internet destinations (target IP, target port). If there is a firewall installed on the router, you might have to adjust the firewall settings.
- On the router with Network Address Translation), no port forwarding must be entered. Potential communication problems can thus be prevented.
- There must be no packet filtering or manipulation for SIP packets installed on the router.
- The routers and network switches with router function must forward the Multicast telegrams (telegrams with destination address 239.0.0.0 to 239.255.255.255) required for the Speedwire connection to all nodes of the Speedwire network.
- All network components used must support the IGMP protocol, minimum version 3 (IGMPv3) (see network component documentation).

#### Procedure:

- Connect the Speedwire devices to the router (see Speedwire device documentation).

### 8.3.2 Connecting the Sunny Home Manager to the Router

#### Additionally required material (not included in the scope of delivery):

- 1 network cable

#### Network cable requirements:

The cable length and quality affect the quality of the signal. Observe the following cable requirements:

- Cable type: 100BaseTx
- Cable category: minimum CAT5e
- Plug type: RJ45 of Cat5, Cat5e, Cat6 or Cat6a (Cat7 plugs cannot be used)
- Shielding: S/UTP, F/UTP or higher
- Number of insulated conductor pairs and insulated conductor cross-section: at least 2 x 2 x 0.22 mm<sup>2</sup>
- Maximum cable length between 2 nodes when using patch cables: 50 m
- Maximum cable length between 2 nodes when using installation cables: 100 m
- UV-resistant for outdoor use.

**Procedure:**

1. Connect the network cable to the network terminal of the product.

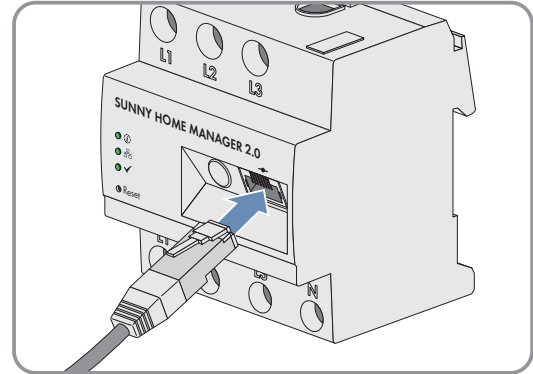

2. Connect the other end of the network cable to the router.

**8.3.3 Testing the Connection to Sunny Portal**

The Sunny Home Manager automatically establishes a connection to Sunny Portal.

**Requirements:**

- The Sunny Home Manager must be supplied with voltage.
- The Sunny Home Manager must be connected to the router.
- DHCP must be active for the router (see router manual). If your router does not support DHCP, you can configure the static network settings on the Sunny Home Manager using the Sunny Home Manager Assistant (see Section 18.6, page 129).

The display of the LEDs serves as control:

Status display LED	Explanation
Status LED: glowing green Performance LED: glowing green	There is an active connection to Sunny Portal and the registration in Sunny Portal has already been executed.
Status LED: glowing green Performance LED: off	The connection to Sunny Portal has been established, but the Sunny Home Manager must still be registered in the portal.
Status LED: flashing red or Performance LED: flashing red	The Sunny Home Manager cannot establish the connection to Sunny Portal automatically.

**Procedure:**

- Check the status of the LEDs.
- ☑ When both the Status and Performance LEDs glow green, you can log in to Sunny Portal with your user data (see Section 9.3, page 37).
- ☑ If only the Status LED glows green, but the Performance LED is off, you must first register the Sunny Home Manager in Sunny Portal and can then log in to Sunny Portal with your user data.
- ☑ If either the Status LED or the Performance LED flashes red, you must use the Sunny Home Manager Assistant (see Section 18.6, page 129) to establish communication.

## 9 Getting Started

### 9.1 Creating a Sunny Home Manager System in Sunny Portal

Sunny Portal is used as the user interface of the Sunny Home Manager. In general and in this document, systems equipped with a Sunny Home Manager are referred to as a "Sunny Home Manager system."

To set up a Sunny Home Manager system for the first time or to set up a new system, you must log into the portal at <https://sunnyportal.com> and register in the **system setup assistant**.

The system setup assistant will guide you through all further steps:

- User registration
- Registration of the Sunny Home Manager system
  - System properties such as the system name and password
  - Registration and identification of the Sunny Home Manager
  - Configuration of the energy meter
  - Extended system properties such as the nominal system power, location, annual yield, feed-in tariffs, and more.

In the User Information column, the system setup assistant provides helpful background information and other information for all entries.

#### **i** Even if you already have a PV system in which you want to integrate a Sunny Home Manager, you have to create a new system.

Only after the Sunny Home Manager has been registered, can other devices in the system be detected or further devices integrated.

In order to be able to transfer the devices of the previous system to the new Sunny Home Manager system, you must first deactivate these devices (usually at least 1 inverter) in the old system. Then you can add the devices to the new system.

The procedure for adding or replacing devices is described under **Configuration > Device overview > Overview of new devices**.

#### Requirements:

- The PV system and all devices in the local network must be in operation and connected to the Sunny Home Manager via a router.
- The registration ID (RID) and the identification key (PIC) must be available. The information can be found on the type label that is attached on the side of the product as well as on the label provided.
- The status LED must glow green and the performance LED must be off on the Sunny Home Manager.
- In order to be able to display PV generation and consumption in your household, energy meters for the measurement of the power- and energy values must be connected. By default, the Sunny Home Manager fulfills this requirement.

#### Procedure:

1. Start the web browser and go to **www.SunnyPortal.com**.
2. Switch the language if necessary.  
In the website's header the default language of your web browser is specified: Click on the arrow next to the language and select the desired language from the drop-down menu.
3. In the field System setup assistant, select **[Register now >]**.
  - The system setup assistant opens and guides you through all the steps.
4. Select **[Next]**.
  - The page **User registration** opens.
5. Activate the field **I am not yet registered** and select **[Next]**.

6. Enter the necessary data for registration.
7. Select [**Next**].
  - After a few minutes you will receive an e-mail containing a link and your access data to Sunny Portal.
8. Follow the link in the confirmation e-mail within 24 hours.
  - Sunny Portal opens a separate window to confirm successful registration.
9. Select [**Next**].
10. Enable the option **Create a new PV system** and enter the required information in the text field **PV system properties**.
11. In the field **PV system name** enter a name for your system. (In this document, the PV system is called **Sunny Home Manager system**.)
12. Enter a PC system password in the field **Password** (see Section 17.2, page 116).

The system password applies for all devices of a system connected via Speedwire and is the same as the device password for the user group **Installer**.

  - If the standard password **1111** is still set on all devices for the user group **Installer**, enter a new system password.
  - If a different uniform password has already been set on all devices, enter this password as the system password.
  - If a uniform password has not been set on all devices, set a uniform password for the user group **Installer** and enter this password in the system setup assistant as the system password.
13. Enter the system password again in the field **Repeat password**.

Tip: Be sure to keep note of this system password. You will need it frequently!
14. Select [**Next**].
15. On the page **Select devices** enter the identification key (PIC) and the registration ID (RID) of the Sunny Home Manager in the fields **PIC** and **RID**.
16. Select [**Identify**].
  - The match between the entered data and the connected device is checked and the detected device is displayed.
17. Select [**Next**].
  - The Sunny Home Manager now searches for devices in the local network. After a maximum of 10 minutes the system setup assistant lists the serial numbers of any available devices in the local network.
18. Select [**Add**] to add the devices to the Sunny Home Manager system immediately.
  - The system password is transferred to the devices. This process can take several minutes. The devices are then shown with a green tick.
19. Select [**Next**].
20. On the **Meter configuration** page, select the desired meter depending on the installation in your house. By default, the integrated meter of the Sunny Home Manager is used as a grid-supply and feed-in meter and the internal measurement of the connected SMA inverters is used for PV generation. Therefore, no additional meter is required.
21. Select the entry **Internal Energy Meter** in the **Purchased Electricity and Grid feed-in** dropdown-list.
22. Select the entry **No energy meter** in the **PV Generation** drop-down list.

If inverters from other manufacturers are also installed in the PV system, an Energy Meter must be inserted between them. Only in this case you must select the entry **SMA Energy Meter xxx** in the drop-down list. Here, **xxx** is the placeholder for the SMA Energy Meter serial number. If there are two SMA Energy Meters in the PV system, select the desired SMA Energy Meter. The generation power of the PV and hybrid inverters is only measured via this selected energy meter. This means that any combination of PV and hybrid inverters can be used.
23. Select [**Next**].
24. On the page **Extended PV system properties** enter your PV system data:

25. Enter the **Nominal system power**.  
You can obtain the nominal system power from your installer.
26. Enter the **Specific annual yield**.  
You can obtain the specific annual yield for your system location from irradiation maps.
27. Enter the data for the location of the system.
28. Enter the **Feed-in tariff** if applicable.  
The feed-in tariff is given to you by your local network provider.
29. If you want to consume the energy produced by your system yourself, to switch loads for example, you have to answer the question of **Self-consumption** with **Yes**.
30. At **Limiting of the active power feed-in**, select the desired option and make the required settings.  
The limitation of the active power feed-in may have to be set according to the specifications of your grid operator.
31. Set **Automatic updates**: the automatic updates must be activated to ensure smooth communication within the system.
32. Enter the **E-mail address of the operator**.
33. Select [**Next**].
  - The system setup assistant shows a summary of your entered data. You have the possibility to check your information and correct it if necessary.
34. If all the information is correct, select [**Finish**].
  - The basic configuration is completed.
  - Sunny Portal will confirm on the next page that your system registration was successful.  
A message also appears indicating that communication monitoring has been activated and that you will receive a daily report by e-mail every day.
35. To go to the Sunny Home Manager system, select [**To the PV system**].
  - The user interface of your system opens.

1
2
3
4
5
6
7
8

### PV System Summary

PV System Properties	
PV System Name:	<input type="text"/>
PV system power:	1 kWp
Specific Annual Yield:	1000 kWh / kWp
Zip Code/City:	<input type="text"/>
Country:	United Kingdom
Time Zone:	(UTC+01:00) Amsterdam, Berlin, Bern, Niestetal, Rome, Stockholm
Automatic updates:	Active
Feed-in Tariff:	<input type="radio"/> United Kingdom Pounds (GBP) / kWh
PV system with self-consumption:	Yes
Limiting of the active power feed-in:	max. 70 % of the nominal PV system power (equates to 0.700 kW)
Supply and feed-in:	Internal energy meter
PV power generation:	no meter
Approve system for Sunny Places:	Deactivated
E-mail address of the operator:	<input type="text"/>

Back
Finish

Figure 7: Entries for setting up a system (example)



## 9.2 User Interface of the Sunny Home Manager System

### 9.2.1 Accessing the user interface

If you have only created one system in Sunny Portal, you will automatically access the user interface of your system after logging into Sunny Portal. If you have several systems in Sunny Portal, you will need to access the user interface of the Sunny Home Manager system after logging into Sunny Portal.

#### Procedure:

1. Log into Sunny Portal (see Section 9.3, page 37).
  2. Select **PV System Selection > "Sunny Home Manager system"** in the page and menu selection.
- The user interface of the system opens.

### 9.2.2 Overview of the User Interface

When you call up your system for the first time, the **Configuration > Current Status and Forecast** page is displayed as the home page.

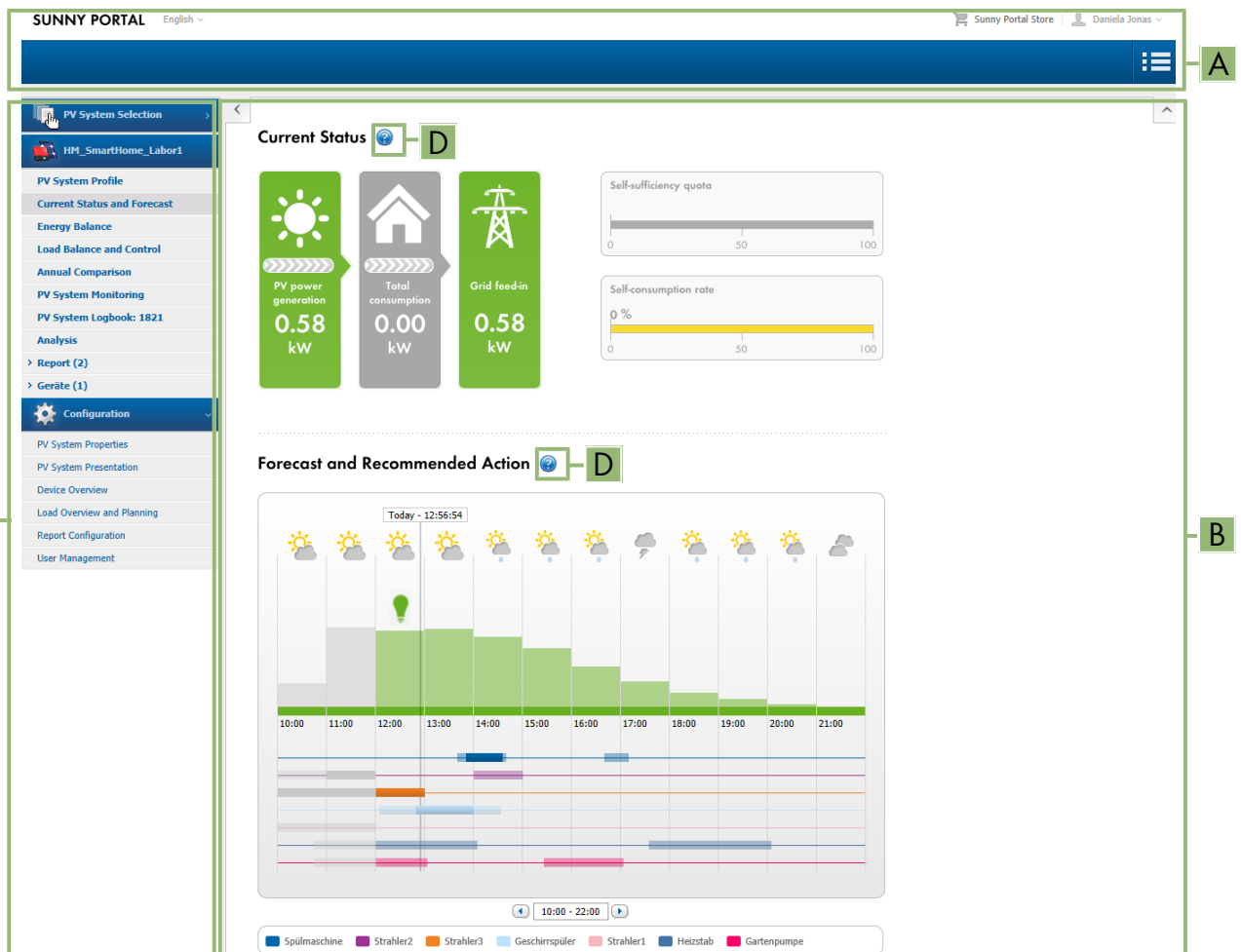

Figure 8: User interface of the Sunny Home Manager system in Sunny Portal (example)

Position	Designation	Explanation
A	Header	<ul style="list-style-type: none"> <li>• Selection of the user interface language</li> <li>• Logout from Sunny Portal</li> </ul>
B	Content area	<ul style="list-style-type: none"> <li>• Contents of the selected page</li> </ul>









Position	Designation	Explanation
C	Page and menu selection	<ul style="list-style-type: none"> <li>Access to the various pages and menus of the Sunny Home Manager system</li> </ul>
D	Help	<ul style="list-style-type: none"> <li>Explanation of the content of the selected page</li> <li>Link to Sunny Portal help</li> </ul>

You can change your home page in the **Configuration** menu under **System presentation > System start page** at any time (see Section 15.4, page 112).

## Further Information on the Content Area

### Selection of frequently used symbols

In the content area of menu pages you can get helpful information and switch to the Configuration menu to make or adjust settings in your system.

Symbol	Explanation
	Help: Provides background information and further explanations.
	Info: Provides information on individual data entries.
	Configuration: Forwards you to the Configuration menu.
	Properties: Forwards you to setting the properties of a device.
	Parameters: Forwards you to setting the parameters.
	Logbook: Forwards you to the system logbook.
	Submenu: For diagrams, opens a varying selection of further options for action, depending on the menu page.
	Recycle bin: Deletes data.

For diagrams and tables, you can often set the display period, change the display of the view, or save and print data. You can find specific information on the relevant content page.

### Important Functions of the Mouse

When you move the mouse pointer over a symbol (mouse-over), an explanation of the meaning of the symbol is usually displayed. Clicking on the symbol enables the underlying command.

In diagrams, you can use the mouse pointer to display the data for a specific point in time.

## 9.2.3 Overview of Menus and Pages

Depending on your system design and the products installed in your system, you may not see all menus and pages listed here.

## System Selection Menu

The name of the currently chosen plant will be used for the main menu item under the **Plant selection** main menu. All other pages always refer to the currently selected system. The menu is only shown if your e-mail address is assigned to more than one plant. In this menu you can select the desired system.

Page	Explanation
System List	Overview of systems that are assigned to your e-mail address.

## "Sunny Home Manager System" menu

This menu contains all information, data, and visualizations for your system. You can usually adapt the visual representation of the data in the tables and diagrams shown here to your wishes and needs. You can also access the associated page from each page in the configuration menu to make changes in the configuration of your system.

Page	Explanation
System overview	Overview of the most important information about your system. To obtain more detailed information on individual data, you can switch directly from this page to the more specific pages.
PV System Profile	Overview with information for the current system. Sunny Portal compiles the plant profile from information that you have entered on your Sunny Portal pages. Information that you have not entered is not shown in the system profile.
Current Status And Forecast	This page is divided into two areas: <ul style="list-style-type: none"> <li>• The area <b>Current Status</b> visualizes which portions of your household are being supplied with power from the utility grid and from your PV system respectively.</li> <li>• The area <b>Forecast and Recommended Action</b> gives an overview of the expected PV power as well as recommendations on the manual switching-on of loads.</li> </ul>
Energy balance	Visualization of the temporal progression of the power or energy flowing between your PV system, your household, the utility grid and, possibly your battery.
Load balance and control	Display of the power and energy consumption of the connected loads.
Annual comparison	Summary of the total yield and the specific system yield per month in a year overview.
System monitoring	Display of various functions for monitoring the current system: <ul style="list-style-type: none"> <li>• Communication monitoring: monitoring of the communication between Sunny Portal and the devices installed in the system.</li> <li>• Inverter comparison: Only if at least 2 inverters are present in the system, system monitoring by comparing the inverter yields.</li> <li>• SMA Smart Connected</li> <li>• System configuration: Only if new devices have been identified in the system and these still need to be configured.</li> </ul> <p>If an exclamation mark is displayed in the page and menu selection next to the System Monitoring menu item, this indicates either an error in the communication or a device configuration that still needs to be completed.</p>
System Logbook	Display of messages in connection with the current system status. These messages help you to identify system disturbances, for example. The number of unread warning, disturbance and fault messages is indicated after the colon.

Page	Explanation
Analysis	<p>Display of the power values of individual or multiple devices or the overall system for the period selected with the tab. You can choose between the display types <b>absolute</b> or <b>specific</b>.</p> <p>A summary of the current diagram data can be found under <b>Details</b>.</p>
Report	<p>The page is divided into <b>Daily system report</b> and <b>Monthly system report</b>.</p> <p>Depending on the selection, meter change of the total yield is displayed.</p>
Machine	<p>Display of the individual devices that are integrated in the system.</p> <p>In separate diagrams, for each individual device the total yield (kWh) over one year and the total yield (kW) as well as the power (kW) on a defined day is shown.</p>

## Configuration Menu

When logging in to Sunny Portal, the menu **Configuration** is collapsed by default.

The main purpose of the configuration menu is the basic setup of your system and changes you want to make to general system settings or for the configuration of your devices. You can also carry out all configurations directly from the respective pages of the menu "Sunny Home Manager system".

Most data and graphics are only fully displayed on these pages if both a feed-in meter and grid-supply meter are connected. The Sunny Home Manager functions both as a feed-in meter and grid-supply meter.

Refer to the User rights (see Section 16.1, page 113) to find out which individual configurations of the system you can carry out.



Page	Explanation
System properties	On this page, you can use the various tabs to configure your Sunny Portal system.
PV System Presentation	You can release selected pages of your system for viewing, include your system profile into your own internet presence, and specify which Sunny Portal page is to be displayed first for your PV system upon login or after switching PV systems.
Device Overview	List with all devices of your system. You can call up device properties, parameters, and messages of these devices. You can search for new devices and update the list.
Load Overview and planning	Display of all loads configured with the Sunny Home Manager. Load planning shows loads for which certain time periods are configured and when these loads are to operate.
Report configuration	On this page you can configure Sunny Portal to inform you by e-mail of events and other information such as yield.
User administration	List of all users to whom you have granted access to the system.

## 9.2.4 Working with Diagrams

### 9.2.4.1 Setting the Display Period

The control element for setting the display period can be found below each diagram.

#### Procedure:





- If there is a time bar with a slider below the diagram, keeping the left mouse button pressed, click on the blue arrow and set the desired time period.
- If there is a date and arrow icons below the diagram, set the date using the arrow icons or a calendar:
  - Scroll  backwards or  forwards with the arrow icons and select the date.

- Click on the date between the arrow icons and select the desired date in the calendar.
- If there are drop-down lists between the arrow icons, select the desired time period in the drop-down lists.



### 9.2.4.2 Saving Diagram Data

You can save diagram data as csv files.

#### Procedure:

1. If the gearwheel icon  is displayed on the right below the diagram, move the mouse pointer onto the gearwheel icon  and select in the drop-down menu .
2. If there two icons are displayed on the right below the diagram, select .
3. Click on [**Save**].
4. Select the target directory.
5. Click on [**Save**].

### 9.2.4.3 Printing Diagram Data

1. Move the mouse pointer onto gearwheel icon  on the right below the diagram.
2. In the drop-down window select .
3. Select [**Print**].
4. Select the desired printer and select [**Print**].

## 9.3 Logging In and Out of Sunny Portal

### Logging into Sunny Portal

#### Requirements:

- The Sunny Home Manager must be registered with the system setup assistant in Sunny Portal.

#### Procedure:

1. **Go to [www.sunnyportal.com](http://www.sunnyportal.com).**
2. In the **Login** area, enter the e-mail address in the field **E-mail**.
3. Enter the Sunny Portal password in the field **Password**.
4. Activate the checkbox **Remain logged in** to stay logged in for your next Sunny Portal visits. This way, you stay logged into Sunny Portal until you log out via the user interface.
5.  **Public or shared computers**  
If you are using a public computer or are sharing yours with other people, deactivate the **Remain logged in** function. Other people could call up your data in Sunny Portal.
6. Select [**Login**].

### Logging out of Sunny Portal

When you log out of Sunny Portal user interface, your PV system will be protected against unauthorized access. The function [**Remain logged in**] is reset in this case.



Figure 9: Logging out of Sunny Portal

#### Procedure:

- Select the user name in the header of the user interface and select [**Logout**].

## 10 Configuration of the Sunny Home Manager system

In the **Configuration** menu on the page **PV system properties** you can change system properties and add details to optimize the functionality of your PV system.

The menu page **PV system properties** includes the following 5 tabs:

- System data
- String configuration
- Operator/installer
- Parameter
- Data release

### 10.1 System data

#### 10.1.1 Overview System Data

This tab lists general data relevant to the PV system. Some of the information is displayed on the **PV system profile** page.

##### System Data Area

Under **PV system data** the name of your PV system, the system identifier, the day of commissioning and the exact location are displayed. Here, you can add to or change these data that were already entered during the registration of the Sunny Home Manager system.

Furthermore, the system can be permanently deleted here.

##### Section: Power

The nominal PV system power is the sum of the power of all PV modules. It can be calculated automatically from the data in the device properties.

The nominal PV system power is required in order to display the following data:

- Specific system yield
- Average expected yield

##### Description

You can describe your system here. The description appears on the **PV system profile** page. The editor can format text, but does not support HTML.

##### PV system image area

Here can replace the standard PV system image with a user-defined system image.

The user-defined system image will also be displayed at the following locations:

- On the **PV system profile** page
- If pages have been released for Sunny Portal, the PV system image will be shown on the list of released systems on the [www.SunnyPortal.com](http://www.SunnyPortal.com) **home page**.

You can save several images in a gallery in Sunny Portal. This makes it easy to change the system image and access your images from different computers.

#### 10.1.2 Changing System Data

##### Requirement:

- You must have the user role **Installer** or **PV System Administrator** (see Section 16.1, page 113).

**Procedure:**

1. In the tab **PV system data**, select the button **[Edit]**.
2. Change the desired PV system data.
3. Click on **[Save]**.

### 10.1.3 Changing the System Name

A sensible name eases the differentiation between other systems in Sunny Portal.

**System name requirement:**

- The system name can have a maximum of 30 characters.

**Procedure:**

1. In the tab **PV system data**, select the button **[Edit]**.
2. In the field **Name**, enter the desired system name.
3. Click on **[Save]**.

### 10.1.4 Deleting the System

If you delete the Sunny Home Manager system, the system and its data will be permanently deleted.

**Requirement:**

- You must be a **system administrator** (see Section 16.1, page 113).

**Procedure:**

1. In the menu **Configuration > System properties** on the tab **PV system data**, select the button **[Edit]**.
2. In the **PV system data** area, select **[Irretrievably delete PV system]**.
  - A security prompt opens.
3. Select **[Yes]** to permanently delete the Sunny Home Manager system.

**i Assigning the Sunny Home Manager to another system**

To enable assignment of the Sunny Home Manager to another system, you must perform a complete reset of the Sunny Home Manager (see Section 11.7.1, page 66).

### 10.1.5 Entering the Nominal System Power

Nominal PV system power is required for limiting active power feed-in.

You must enter the nominal PV system power correctly to ensure limitation of the active power feed-in to the correct value (see Section 10.4.3, page 43). If there are changes to the installed PV system power, you will need to adjust this value.

**Manually enter the nominal system power:**

1. In the field **PV System Power** in the **Power** area, enter the nominal system power.
2. To set the manufacturer of the PV modules, select the manufacturer in the drop-down list **Manufacturer**.
3. To set the module types, select the module types in the drop-down list **Module type**.

**Automatic calculation of nominal PV system power****Requirement:**

- You must have entered the PV array power of all PV and hybrid inverters (see Section 11.4.3, page 62).

**Procedure:**

- In the area **Power**, activate the checkbox **Calculate PV system performance from device properties**.
  - The calculated nominal PV system power is displayed.

## 10.1.6 Changing or Deleting the System Image

### Changing the System Image

#### System image requirements:

- Maximum image size: 500 kB
- Possible image formats: JPG, PNG, GIF

#### Procedure:

1. In the area **PV system image**, select [**Load image**].
2. Select the desired image from one of your directories.
3. Select [**Open**].
4. To change the system image size, move the gray squares with the mouse.
5. To move the image section, click on the image section and move it while holding the left mouse button pressed.
6. Click on [**Save**].
7. To save an image in the gallery, upload the image to the gallery as follows:
8. Select [**Select from the gallery**].
9. Select **Upload**.
10. Select [**Browse**].
11. Select the desired image from one of your directories.
12. Select [**Upload selected file**].
13. Select **X**.
  - The image is saved in the gallery.
14. To upload an image from the gallery as the system image, select [**Select from the gallery**].
15. Double-click the desired image.
16. Click on [**Save**].

### Deleting the User-Defined System Image

If you delete the user-defined system image, Sunny Portal will display the default system image (again).

#### Procedure:

1. Select [**No PV system image**] in the area **PV system image**.
2. Click on [**Save**].

## 10.2 Configuring Strings

A string describes a group of series-connected PV modules. Normally, a system is made up of multiple strings. Each string has specific properties, such as deviation to south (azimuth) or the roof tilt angle.

The configuration of the strings is of fundamental importance for the correct calculation of the PV forecast and thus an important prerequisite for load planning as well as the optimization of self-consumption and the self-sufficiency quota.

The following table explains the properties of a string, partly with examples for settings:

String properties	Explanation
Designation	Name of the string, e.g. <b>String A</b> or <b>East side</b>
Manufacturer	PV module manufacturer



String properties	Explanation
Module type	Depending on the selected manufacturer, different module types are displayed in the drop-down list.
Module power <sup>1)</sup>	These values are applied automatically from the module database once you have selected the module type. You can change the values using  or the arrow keys on the keyboard.
Module surface	
Efficiency	
Number of modules <sup>1)</sup>	Number of modules forming the string
Azimuth	<p>The azimuth angle indicates by how many degrees the module surfaces deviate from a southern orientation.</p> <ul style="list-style-type: none"> <li>In the text field, enter the number of degrees by which the module surfaces deviate from a southern orientation. Enter a negative value (e.g. <b>-20</b>) for a deviation to the east and a positive value (e.g. <b>20</b>) for a deviation to the west.</li> <li>If the module surfaces track the sun automatically, activate the checkbox <b>Tracking</b>.</li> </ul>
Tilt angle	<p>The tilt angle indicates by how many degrees the module surfaces deviate from the horizontal. In some systems, the module surfaces are optimally aligned according to the latitude. In Germany, the optimum orientation is 30 degrees from the horizontal.</p> <ul style="list-style-type: none"> <li>In the text field, enter the number of degrees by which the module surfaces deviate from the horizontal.</li> <li>If the module surfaces are optimally aligned according to the latitude, activate the checkbox <b>Optimized</b>.</li> </ul>
Description	Optional, e.g. <b>String A - Orientation to the east</b>

## Creating New String

### Requirement:

- The system must contain at least 1 inverter.

- Under **Configuration > PV system properties** select the tab **String configuration** and then **Add string**.
- In the **Inverter** line, from the drop-down list select an inverter to which the string is to be assigned (see Section 11.1, page 50).  
You can register the connected strings for all inverters. To initially register the same configuration for all devices, select **Apply for all inverters** when adding a string.
- Enter the string properties (compare table).
- Select **[Accept]**.
- Click on **[Save]**.

## Accept existing string and edit

### Requirement:

- At least 1 string must already be configured in your system.

### Procedure:

- Select 1 string or inverter shown in the table on the tab **String configuration**.
- In the line of the selected string and the column **Copy**, select .

<sup>1)</sup> Relevant for calculation of the nominal system power

3. In the column **Edit** of the copied string line, select .
  - The menu for setting the string opens.
4. Enter the string properties:
5. Click on [**Save**].

### 10.3 Changing Operator Data

The contact data of the operator and the installer are listed on the tab **Operator/installer**.

The operator is a private individual or legal entity who owns PV systems for business purposes, for example. The operator can farm out use of the PV system without necessarily being the user himself.

The name of the operator is displayed on the page **PV system profile**.

#### Requirement:

- You must have the user role **Installer** or **PV System Administrator** (see Section 16.1, page 113).

#### Procedure:

1. In the tab select [**Edit**].
2. Enter the operator data.
3. Click on [**Save**].

### 10.4 Configuring parameters

#### 10.4.1 General Information about the Configuration of the Parameters

The following is required for configuration within the tab **Parameters**:

- You must have the user role **Installer** or **PV System Administrator** (see Section 16.1, page 113).

You can find the button [**Edit**] on the very bottom of the tab **Parameters**. It applies to all parameter settings of this tab.

When selecting [**Edit**], you can change settings of different parameters and apply all changes at once with the button [**Save**].

If you do not want to apply the changes, select [**Cancel**].

Both the buttons [**Save**] and [**Cancel**] are also on the very bottom of the tab.

Tip: Since all the changes are either applied with [**Save**] or dismissed with [**Cancel**] for the entire tab, it is recommended to save each change made on this tab separately.

#### 10.4.2 Entering the Feed-In Tariff and Electricity Tariff

The values for feed-in tariff and electricity tariff were already queried and possibly entered during the system registration.

The question about self-consumption was also already asked when the system was being registered. Here you can change your previous setting if necessary. You can either use the electricity generated by your PV system for self-consumption or sell it, i.e., feed it into the utility grid. The Sunny Home Manager uses this information for cost saving and takes the entered values into account during load control to optimize self-consumption.

The entered values affect:

- Recommended actions for manually switching on loads **Current status and forecast > Forecast and recommended action**
- Load control via the Sunny Home Manager (either directly via the local network or via switching devices such as a radio-controlled sockets or a relays)

#### Procedure:

1. Enter the feed-in tariff per kWh in the area **Reimbursement** in the text field **Feed-In Tariff**. Also select the desired currency in the accompanying drop-down list.

2. In the text field **PV system with self-consumption**, select whether self-generated PV energy is consumed in your household (self-consumption).
  - If you select **Yes**, the self-consumption of the household is taken into consideration in the load planning and recommended actions.
  - If you select **No**, loads cannot be integrated into the energy management of the Sunny Home Manager. A corresponding message will appear and you will be asked to either confirm or change your decision.
3. In the area **Electricity Tariff**, enter the time for which the electricity tariff applies in the input fields **From** and **To**.  
Tip: Split the night tariff into two tariffs. Configure the first tariff up to 12 midnight. Configure the second tariff from 12 midnight.
4. Enter the electricity tariff that applies to the entered time in the input field **Price**.
5. If the electricity tariff only applies to specific weekdays, activate the checkboxes with the respective weekdays.
6. If the electricity tariff applies to each weekday, activate all weekday checkboxes.
7. To enter additional electricity tariffs, select  and enter the data.
8. Click on [**Save**].

### 10.4.3 Configuring Limitation of Active Power Feed-In

#### Requirement:

- The parameter **Operating mode active power setting** must be set to **Active power limitation P via system control** or to **External specification** for the inverters.

#### NOTICE

##### **Responsibility of the system operator for limitation of active power feed-in**

The system operator is responsible for the accuracy of the information on limiting the active power feed-in and the nominal system power.

- Ask your grid operator beforehand whether you are permitted to use the Sunny Home Manager to limit active power feed-in (Manufacturer's Declaration "Feed-In Management in Accordance with the Renewable Energy Sources Act (EEG) 2012 with Sunny Home Manager (SHM) from SMA" available at [www.SMA-Solar.com](http://www.SMA-Solar.com)).
- Set the limitation of active power feed-in required by the grid operator. If you are not sure about this, contact your grid operator.
- Ensure you have correct information on the nominal PV system power. If you extend the system, adjust the value for the nominal PV system power accordingly.

- i** Ensure that your feed-in meter complies with the requirements.

If your grid operator only allows a certain active power feed-in into the utility grid, the Sunny Home Manager can monitor and fulfill this requirement by reducing the PV generation of the inverters when the specified limit is exceeded. This takes into account that in times when your PV system generates a lot of PV power, which is also used directly by loads - household appliances or a battery that is being charged - a PV power higher than the feed-in limitation is allowed regardless (dynamic active power limitation).

In addition to the dynamic limitation of PV generation, the Sunny Home Manager can also use intelligent energy management to ensure that loads in the household are switched on at precisely those times when so much PV energy is available that the feed-in limit will be reached. If switching on a load means that more power is consumed directly in the household, the PV generation must not be reduced by as much or must not be reduced at all.



### Limitation of the active power feed-in to 70% of the nominal PV system power

Due to high levels of solar irradiation, the system (system size: 10 kWp / feed-in limit: 7 kW) can currently produce 90% of the nominal PV system power.

- 20% of the nominal PV system power is currently being consumed by loads in the household. The remaining amount of 70% of the nominal PV system power is being fed into the utility grid. No limitation of PV generation is required.
- A load is switched off and only 10% of the nominal PV system power is consumed in the household. As a result, 80% of the nominal system power is available for feed-in to the utility grid – more than allowed. The Sunny Home Manager reduces PV generation from the theoretically possible 90% of nominal PV system power to 80%. 70% of the nominal PV system power continues to be fed into the utility grid.

A limitation of the active power feed-in can be entered as follows:

- Limitation to a fixed value of the nominal system power in kW (setting range: 0 kW bis 51.480 kW)
- Limitation to a percentage of the nominal system power (setting range: 0% to 99%)
- Zero export – blocks grid feed-in into the utility grid (setting: 0% or 0.000 kW of the nominal system power). Due to control cycle times, an inevitable remaining quantity of energy might nevertheless be fed into the utility grid.

You can use a function test to check the limitation of the active power feed-in:

- In the **Limitation of active power feed-in** section, select the option button **max. xx kW** and enter the value **0**. Thus, the Sunny Home Manager immediately limits the active power when the inverters starts feeding into the utility grid.

### **i** Supported inverters for the limitation of the active power feed-in to 0%

The limitation of the active power feed-in to 0% is only supported by inverters that support the fallback function. In the event of a communication failure between the Sunny Home Manager and the inverter, the inverter reverts to an output power of 0 watts. For more information see the inverter manual at [www.SMA-Solar.com](http://www.SMA-Solar.com).

If a battery or hybrid inverter is part of your system, after a defined limit of the nominal system power is set, you can include the battery or hybrid inverter in the energy management and use the surplus energy to charge the battery-storage system.

#### Procedure:

1. In the area **Limiting of the active power feed-in**, select the applicable option:
2. If limitation of active power feed-in is not required for your system, select **no limiting of the active power feed-in** (default setting).
3. If limitation of active power feed-in is required for your system, you can fulfill this requirement as follows:
  - If the grid operator requires limitation to a percentage of the nominal PV system power, select the option **Max. xx % of the nominal PV system power** and enter the required percentage.
  - If the grid operator requires limitation to a maximum active power in kW, select the option **max. xx kW** and enter the maximum permitted active power in kW.
  - If the grid operator requires limitation of the active power feed-in to 0% or 0 kW, enter the value **0** in the relevant option.
4. If the grid operator requires closed-loop control in accordance with UNE 217001:2015, you must enable the function **Zero export must be done in accordance with UNE 217001:2015**. Enabling the function may result in the need for slightly higher grid-supplied power from the utility grid to ensure this type of control.

5. If your system has a battery or hybrid inverter and you have set the nominal system power to a value **< 10%** or **< xx kW** (the corresponding value of the nominal system power), you can use the surplus energy to charge the battery-storage system. To do this, enable the option button **Including the battery inverter**.
6. Click on [**Save**].
  - The data is being transferred. This process can take up to 5 minutes. In the page and menu selection **Energy balance > Day**, the specified limitation of active power feed-in is displayed as a dotted red line in the diagram **Generation**.
  - In the page and menu selection **Energy balance > Day**, the specified limitation of active power feed-in is displayed as a dotted red line in the diagram **Generation**.

#### 10.4.4 Activating or Deactivating Grid Management Services

As part of grid management services, it may be necessary to implement grid operator specifications for active power limitation and for reactive power feed-in in your PV system. The Sunny Home Manager can receive these specifications via Ethernet-based communication. The grid operator can set up this link. For this, you have to activate grid management services for the Sunny Home Manager.

##### Procedure:

1. Select the appropriate option in the area **Grid management services via Ethernet based communication**:
  - If the Sunny Home Manager does not have to implement any grid operator specifications, select **No** (default setting).
  - If the Sunny Home Manager has to implement any grid operator specifications, select **Yes**.  
The default setting Port **502** can normally remain set.
2. Change the port if necessary:
 

If there are several Modbus devices in the network or if the grid operator specifications are to be transmitted via a certain port, enter this port in **Port xxx**.

If you change this port, you must also change the port in your VPN router and inform the grid operator of this change.
3. Click on [**Save**].
  - The data is being transferred. This can take up to 5 minutes.

#### 10.4.5 Entering time period control for charging the battery-storage system

The time period control is only available for systems with Sunny Island, Sunny Boy Storage or Sunny Tripower Smart Energy.

It might make sense to charge battery-storage systems at defined times (typically at low tariffs at night) due to time-dependent electricity tariffs from the electric utility company.

The time period control for battery charging competes with the regular control of a battery or hybrid inverter. As soon as a time period for battery charging has been defined, the values energy self-sufficiency / self-consumption quota and self-sufficiency quota / self-consumption quota are therefore hidden in the energy balance of the system. Background: Due to set specifications of the battery charging power and time periods, it is likely that energy from the utility grid is also used for charging the battery. This can distort the above-mentioned values significantly and permanently. Should all time frames be removed at a later time, incorrect values might then be displayed.

You can specify time periods for several days as well as several consecutive time periods within a specific day.

##### Procedure:

1. In the **Time period** area click on **+**.
2. Enter time interval (in 15 minute steps).
3. Select the period for which this time interval shall apply.
4. Enter the charging power in W.

5. To enter another time period, click on **+** again and repeat the procedure.
6. You can undo unwanted entries with **-**.
7. Confirm all your entries with **[Save]**.

## 10.4.6 Entering Peak Load Shaving

This function was primarily developed for the Belgian Market and may not be useable yet in other countries.

In addition to optimizing the self-consumption portion by integrating electrical loads into the energy management system and what is known as atypical grid use (switching on loads specifically at times when your solar system is providing a lot of its own energy), you can save further electricity costs by reducing your power consumption from the utility grid through intelligent setting of your battery storage system.

An increased energy demand at certain times of day (e.g. in the morning or in the evening) leads to so-called load peaks, which can have you classified into a higher tariff category.

The battery-storage system allows you to capture, i.e. "shave" these load peaks with stored electric current. The following settings are used for this:

Setting	Explanation
Peak load shaving	By activating the operating mode "Peak load shaving", you can specify the maximum power supply from the utility grid as well as a limiting value for the portion of the total storage capacity of the battery system for the peak load shaving.
Grid-supply limit Range: 0 kW to 100000 kW Default: 0 kW	<p>The grid-supply limit specifies the maximum power that may be drawn from the transmission line. When this power is exceeded, the energy required is drawn from the battery.</p> <ul style="list-style-type: none"> <li>As soon as the battery is discharged, the corresponding load can no longer be operated.</li> <li>In order to be able to operate a load despite the battery's insufficient state of charge, the grid-supply limit can be increased temporarily; see 'adaptive increase'. In this case, the load is operated with electric current additionally drawn from the utility grid, which needs to be compensated for as well.</li> </ul>
SOC limiting value Range: 0% to 100% Default: 50%	<p>By entering a SOC (state of charge of the battery) limiting value, the total storage capacity of the battery system can be divided:</p> <ul style="list-style-type: none"> <li>Below the limiting value: used for peak load shaving</li> <li>Above the limiting value: used for increased self-consumption</li> </ul> <p>If the value 40% is entered, for example, 60% of the battery charge can be used at times when the currently generated solar power is insufficient for the desired electricity supply; a base of 40% is reserved for shaving current peaks.</p>
Adaptive increase of the grid-supply limit	When activating, you choose to automatically adjust the grid-supply limit indicated above to the new maximum value if the grid-supply limit could not be met, e.g. due to insufficient battery charge (see above).
Automatic reset and starting point	<p>If the option <b>Adaptive increase of the grid-supply limit</b> was selected, you can specify that the grid-supply limit be reset to the value originally entered manually for the grid-supply limit after a certain (accounting) period.</p> <p>You can specify this accounting period via the drop-down menus <b>Accounting period</b> and <b>Start</b>.</p>

**Requirement:**

- Your system must have at least one battery-storage system, i.e. it must have at least 1 battery inverter or 1 hybrid inverter.

The following inverters support this function:

- Sunny Boy Storage, all power classes
- Sunny Island of the type SlxxM-12, SlxxH-12, SlxxM-13 und SlxxH-13
- Sunny Tripower Smart Energy, all power classes

**Procedure:**

1. In the **Configuration > System properties** menu, click on the **Parameter** tab.
2. Select **Edit**.
3. In the **Peak load shaving** area, select the option **Yes**.
4. Under **Grid-supply limit** enter the desired power in kW that you want to draw from the utility grid at a maximum.
5. As a **SOC limiting** value, enter a percentage up to which the battery storage capacity should only be used for peak load shaving.
6. If you want to avoid an interruption in the power supply when the battery is insufficiently charged, activate the option **Adaptive increase of the grid-supply limit**.
7. If you have the option **Adaptive increase of the grid-supply limit** activated, the input mask expands and offers you the possibility to limit this option.  
To set a time limit, you must activate the option **Automatic reset and starting point** and then select an **Accounting period** from the drop-down menu as well as the starting point **Start**.
8. Click on [**Save**].

### 10.4.7 Setting the Optimization Target

The optimization target indicates whether the Sunny Home Manager should prioritize ecological or economical factors during load management:

- ecological: highest possible self-consumption  
Greater self-consumption conserves the environment because there is no energy loss caused by the transport of current through the utility grid.
- economical: highest possible cost savings  
The Sunny Home Manager calculates the most financially rewarding control of the loads, taking into consideration the electricity tariff. In certain cases, it may be more economical to feed the PV electricity into the utility grid and to operate the individual loads at night using electricity purchased from the grid.

The optimization target affects the following components:

- Load control with Sunny Home Manager
- Recommended actions in the diagram **Forecast and Recommended Action** on the page **Current Status and Forecast**

**Requirement:**

- The feed-in tariff and electricity tariff must be entered (see Section 10.4.2, page 42).

**Procedure:**

1. In the area **Optimization Target**, click the slider and, holding the left mouse button pressed, set the optimization target:
  - To achieve the highest self-consumption possible, move the slider towards **ecological**.
  - To achieve the greatest possible cost savings, move the slider towards **economical**.
2. Click on [**Save**].

## 10.4.8 Entering the Amount of CO<sub>2</sub> Avoided

The CO<sub>2</sub> factor indicates how much CO<sub>2</sub> is produced for one kilowatt hour of electric current generated in the country. Depending on the technology used and the efficiency, the CO<sub>2</sub> factor can vary between the different electric utility companies in the region. You can find out the value of the CO<sub>2</sub> factor of the electric current supplied in your region from your electric utility company.

Sunny Portal can use the CO<sub>2</sub> factor to calculate how much CO<sub>2</sub> was saved due to the power generation of your system.

You can view the value of CO<sub>2</sub> avoided on the following pages:

- System profile
- Report configuration

### Procedure:

1. In the area **Factor**, enter the CO<sub>2</sub> factor in the text field or click the slider and, holding the left mouse button pressed, set the CO<sub>2</sub> factor.
2. Click on **[Save]**.

## 10.4.9 Entering the Expected Yield

### Entering the Predicted Annual Yield

Sunny Portal can display in a table how the predicted annual yield of your system is likely to be distributed throughout the months of the year.

The predicted annual yield of the system is calculated from the specific annual yield (kWh/kWp) at the system location multiplied by the nominal PV system power (kWp).

You can obtain the specific annual yield for your system location from irradiation maps. Local conditions such as the shading or orientation of the system are not taken into account by Sunny Portal. You can obtain the nominal system power (also called nominal power) from your installer.

### Requirement:

- The nominal PV system power must be set (see Section 11.4.3, page 62).

### Procedure:

1. In the area **Yield Expectations**, enter the specific annual yield in the text field **Specific Annual Yield**.
2. To enable configuration of the average expected yield and the monthly distribution on the page **Annual Comparison**, activate the checkbox **The monthly distribution can be configured in the diagrams**.
3. Click on **[Save]**.

### Entering the monthly distribution of the predicted annual yield

The monthly distribution shows how the predicted annual yield is likely to be distributed throughout the months of the year.

You have the following options:

- Having Sunny Portal Suggest the Monthly Distribution
- Entering the monthly distribution manually

### Requirement:

- The system location must be entered (see Section 10.1.2, page 38).

### Having Sunny Portal suggest the monthly distribution:

1. In the area **Yield expectations**, select **[Suggest a Monthly Distribution]**.
  - The monthly distribution is displayed in the table with the months.



2. To display the average expected yield and the monthly distribution in the diagrams on the pages **Annual Comparison** and **Energy and Power**, activate the checkbox **Display the monthly distribution in the yearly comparison, as well as energy and power**.
3. To enable configuration of the average expected yield on the pages **Annual Comparison** and **Energy and Power**, activate the checkbox **The monthly distribution can be configured in the diagrams**.
4. Click on [**Save**].

#### Entering the monthly distribution manually:

1. In the area **Yield Expectations**, enter the values in the fields **in %** in the table with the months. The sum must add up to 100%. You can change these values at any time to get a better distribution.
2. To display the predicted annual yield and the monthly distribution in the diagrams on the pages **Annual Comparison** and **Energy and Power**, activate the checkbox **Display the monthly distribution in the yearly comparison, as well as energy and power**.
3. To enable configuration of the predicted annual yield on the pages **Annual Comparison** and **Energy and Power**, activate the checkbox **The monthly distribution can be configured in the diagrams**.
4. Click on [**Save**].

## 10.5 Releasing Data

SMA takes the security of your data very seriously. This applies to personal and system-related data. We guarantee that your data will be treated confidentially and will not be used by SMA or third parties for any other purpose without your explicit agreement. You can specify here to what extent SMA or third parties may use your data. You can withdraw your consent to the use of your data at any time with effect for the future.

For example, on this page you can indicate if you want to participate in the SolarCoin program.

# 11 Device Administration

In the menu **Configuration > Device overview** you can configure and add devices to your Home Manager system as well as replace. You also obtain information on all the devices in your system.

## 11.1 Device Overview Tab

The device overview tab displays information on all the products that have already been configured in your PV system. If new devices were detected in the system, this also is shown. When you select [**Set up devices now >>**], you are redirected to the **Overview of new devices** tab. (see Section 11.2, page 52) From there you are forwarded to the configuration of these new devices (see Section 11.2.2, page 54).

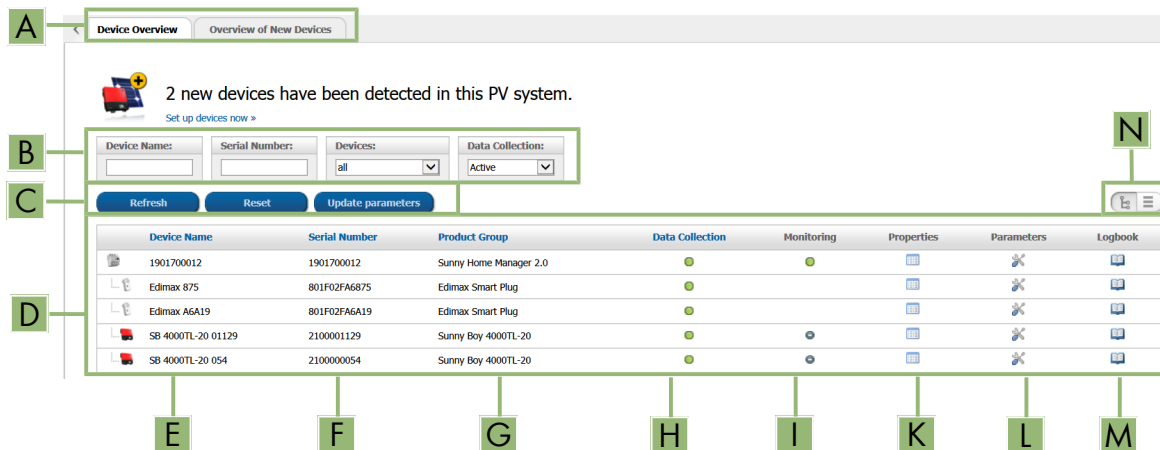





Figure 10: Device overview tab (example of new devices having been detected.)

Position	Designation	Explanation
A	Tabs of this menu page	<b>Device overview</b> tab is active.
B	Filters	Text fields and drop-down lists for filtering the device overview
C	Buttons	These buttons refer to the filters (B): <ul style="list-style-type: none"> <li>• <b>Update</b> or <b>Reset</b> - refers to the previously set filter</li> <li>• <b>Update parameters</b> - updates the parameters of all devices</li> </ul>
D	Device list	–
E	Device name	Symbol and name of the device
F	Serial number	Serial number of the device
G	Product group	Product group of the device, e.g. Sunny Home Manager 2.0, Sunny Boy 4.0 1AV-41
H	Data collection	Displays whether the data of this device is to be used on your Sunny Portal pages (●).
I	Monitoring	Displays whether the communication monitoring or the inverter comparison is activated (●) on the devices.
K	Characteristics	Opens the tab <b>Device: #</b> with information on the device each selected. Depending on the device and the device settings, various device properties can be displayed on the tab of the device.  You can make settings on the devices by using the <b>Properties</b> [icon].

Position	Designation	Explanation
L	Parameter	Opens the <b>Parameters</b>  tab with the parameters of each the selected device. You can read off the software package version in the parameter list. The parameters of a device are described in the respective device manual. The device parameters on this page can only be read but not changed. However, you can have previous changes displayed in the column History  .
M	Logbook	Opens the tab <b>System logbook</b>  with the messages for this device.
N	Table display	Device display in hierarchal tree structure or as list.

### 11.1.1 Filtering the Device Overview

You can find individual devices more easily if you filter the device overview. You have the following options for this:

Text field or drop-down list	Explanation
Device name	Complete name of the device or parts of the device name
Serial Number	Complete device serial number or parts of the serial number
Machine	Searched device class
Data collection	<ul style="list-style-type: none"> <li>• <b>All</b>: both activated and deactivated devices are shown.</li> <li>• <b>Active</b>: only activated devices are shown.</li> <li>• <b>Deactivated</b>: only deactivated devices are shown.</li> </ul>

#### Procedure:

1. Set one or more filters.
2. Select [**Refresh**].  
Tip: In the list view  you can sort the devices in the device overview in ascending or descending order by clicking the blue entries in the table header.
3. To clear the filter, select [**Reset**].

### 11.1.2 Configuring the Device Properties

On the page **Device overview** you can view the **Properties**  for each listed device and, depending on the user right, verify and change the current configuration of a device.

#### Requirement:

- You must have the user role **Installer** or **PV System Administrator** (see Section 16.1, page 113).

The configuration options depend on the **device class**. Only the device properties area is available for all device classes.

### 11.1.3 Changing Device Names and Description

The serial number of the device is displayed as the default device name. You can enter any description for each device. The description of the device is displayed in **Device Properties**. This information enables the device to be uniquely identified.

#### Procedure:

1. Enter a device name in the field **Device Name**.  
The maximum length of the device name may be 20 characters.

2. Enter a description in the field **Description**.
3. Click on [**Save**].

### 11.1.4 Activating Data Acceptance

You can set whether or not Sunny Portal should accept and display data of the devices integrated in the system.

Only if you enable the data collection for a device, can Sunny Home Manager capture and use the data of this device for monitoring, forecast and control.

 The device must not be the Sunny Home Manager.

#### Requirement:

- You must have the user role **Installer** or **PV System Administrator** (see Section 16.1, page 113).

You must **Activate** data collection:

- for **Inverters**:  
if you want to monitor the power of an inverter (and thus the system) or compare yields of different inverters to each other
- for **radio-controlled sockets/relays** and for **Smart appliances**:  
if you would like to control loads indirectly or directly via the interface included in the device
- for other connected devices:  
if they are to be displayed in the portal.

In the following cases, you must **deactivate** the data collection of a device in Sunny Portal:

- You no longer wish to display the device in Sunny Portal  
or
- You have removed the device from your PV system  
or
- You would like to replace the device in Sunny Portal by another device.

The data of the deactivated device is retained in Sunny Portal and remains visible on the menu page **Evaluation**.

#### Procedure:

1. Call up the device **properties** of the required device in the menu **Device overview**.
2. Select [**Edit**].
3. Place a checkmark in the field **Active** under **Data collection** to activate data collection.
4. Remove the checkmark in the field **Active** under **Data collection** to deactivate data collection.  
If data collection has been **Deactivated** for a device, the device is not listed in the device overview with the filter setting **Active**.
5. Click on [**Save**].

## 11.2 Overview of New Devices Tab

On the **Overview of new devices** tab, all newly connected devices are displayed.

Adding devices to the system and replacing devices is done primarily through the configuration wizard. The configuration wizard guides you through the individual steps. Depending on the device type, different information is requested.

Device Overview
Overview of New Devices



## 4 new devices have been detected in this PV system.

**With which configuration would you like to add the new devices to this Sunny Portal PV system?**

**+ As a PV System Extension (Additional Device)**  
(configuration assistant opens)

- Edit the device name
- Adjust generator power





**↔ As a Replacement Device**  
(configuration assistant opens)

- Before starting the configuration wizard, you must deactivate the data acceptance of the device to be replaced.
- Select the device to be replaced
- Transfer data to the replacement device

Please select the respective configuration for every device in the list.

**Important Information:** Incorrect allocation of new devices may lead to faulty display.

▶ Device Filter

Selection	Device	Product Group	Serial Number ▲	Configuration	Delete
<input type="checkbox"/>		Inverter		+ ↔	✖
<input type="checkbox"/>		Inverter		+ ↔	✖
<input type="checkbox"/>		Inverter		+ ↔	✖
<input type="checkbox"/>		Radio-controlled Socket/Relay		+	✖

You can add 21 devices. i

Add

Notice: Only PV system extensions will be added immediately.

Refresh devices

Figure 11: New Devices tab (example)

### 11.2.1 Maximum Number of Supported Devices

The Sunny Home Manager supports a maximum of 24 devices.

The term device includes all components that exchange data with the Sunny Home Manager, i.e. SMA inverters (including 1 battery or hybrid inverter per system at most), switching devices such as radio-controlled sockets and relays, and also smart appliances (including a maximum of 3 SMA EV Chargers per system). SMA Energy Meters assigned in the meter configuration for grid-supply and feed-in as well as for PV generation are not counted as such devices.

Of the 24 devices, a maximum of 12 devices can be actively controlled by the Sunny Home Manager.

Actively controlled means that the Sunny Home Manager not only displays the energy consumption of the device – a direct load or a load connected via a switching device – but also actively switches the device. Beyond the limit of 12 devices, further devices up to the maximum number of 24 devices can be monitored and visualized via switching devices, but not switched.



### Fully equipped energy management system

A fully equipped energy management system (with a maximum of 24 devices) can consist, for example, of the following components:

- 2 x SMA PV inverter
- 1 x SMA battery inverter
- 1 x Washing machine (EEBus)
- 1 x Clothes dryer (EEBus)
- 1 x SMA EV Charger (SEMP)
- 1 x heat pump (EEBus)
- 17 x radio-controlled sockets

In this example, the Sunny Home Manager can only actively control 8 of the connected 17 radio-controlled sockets due to the devices already actively controlled via an EEBus or SEMP interface. This means that only those loads can be included in the energy management that are connected to these 8 actively controlled radio-controlled sockets. Of the loads connected to the other 9 radio-controlled sockets, only the energy consumption is measured and visualized.

## 11.2.2 Adding or Replacing Devices

You can only access all devices as an installer or system administrator (see Section 16.1, page 113).

Tip: Keep note of the serial number of the device you want to add.

### **i** You have to capture the new device with the Sunny Home Manager.

The Sunny Home Manager uses the system password to log in to the devices of the system. If new devices (inverters, batteries, etc.) are to be added to the system, the Home Manager must also log in there. For this, the default password 1111 (factory-preset) or the system password must be set for these devices. The Sunny Home Manager then first tries to log in to the new devices with the system password. If this fails, the Sunny Home Manager repeats the process with the preset default password 1111.

#### Requirements:

- The new device must be in operation.
- For the new SMA device, the default password **1111** for the user group **Installer** or the system password of the existing system must be set (see Section 17.3, page 117).
- When adding AVM products, the AVM FRITZ!Box Smart Home control must first be set up (see Section 11.3.4, page 57).

**i** If you need to replace the Sunny Home Manager, you must use the system setup assistant (see Section 9.1, page 30).

### **i** A device can only be assigned to ONE Sunny Portal system.

To use a device that has already been used in another system, it must be deactivated in the old system.

### **i** Device replacement: The old device must NOT be deleted, but deactivated

If you delete the device that you wish to replace from Sunny Portal, all the device data is irretrievably deleted.

- To retain the data of the old device in Sunny Portal, do not delete the old device, but deactivate it.
- Add the new device as an additional device to the Sunny Home Manager system (replacement device).
- If the Sunny Home Manager is to be replaced, the old device must be deleted from the system; deactivation is not possible.

### **i** Smart appliances cannot be replaced

Smart appliances which communicate via a data exchange protocol with the Sunny Home Manager cannot be replaced in Sunny Portal.

- To retain the data of the old load in Sunny Portal, do **not** delete the old load, but deactivate it (see Section 11.1.4, page 52).
- Add the new load as an additional device to the Sunny Home Manager system (system extension).

#### Procedure:

1. Select **Device overview > Overview of new devices** in the page and menu selection.
2. Select [**Refresh devices**]. The Sunny Home Manager then searches for new devices in the local network.
  - After a maximum of 1 minute, all new devices will be displayed and you will be informed how many more devices you can add to your installation if needed.  
Unencrypted devices might not be shown (see Section 11.3.3, page 56).
  - If a new device has been detected in the system, this is also indicated by an exclamation mark in the page and menu selection **System monitoring** and you are prompted to configure this new device under **System monitoring > System configuration**.
3. If you do not want to configure a new device for the time being, you can remove it from the display with **X**.
  - This action does not delete the device from the system (see Section 11.9, page 68), but only hides it. Since the device is not yet configured, only the serial number is registered and will not be lost during this deletion process. You can undo this deletion at any time on the **Overview of new devices** tab by clicking on the line **Restore deleted new device**.  
This deletion is not identical to the process in which a device with all its data is irrevocably deleted from Sunny Portal (see Section 11.7, page 67).
  - If detecting new devices was the only reason for the exclamation mark next to the **System monitoring** menu item, this action will make the exclamation mark disappear.
4. If you want to add several newly detected devices in one step instead of one by one, you can select these devices and click on [**Add**].
  - The selected devices are added directly, i.e. without the configuration wizard. Default values are used for configuration, but you can change them at any time.
5. If you want to add a single device separately, select **+** in the line of the device.
  - The Sunny Home Manager connects to the new device. Page 2 of the configuration wizard opens.
6. To replace a device, select **↔** in the line of the new device.
  - The Sunny Home Manager connects to the new device. Page 2 of the configuration wizard opens.
7. Follow the instructions of the configuration wizard.
  - The new SMA device is displayed under **Configuration > Device overview**.
  - The new device connected via Ethernet is displayed under **Configuration > Load overview and planning**.
  - Replacing a device can take up to 20 minutes.

8. If you have just changed the system password of the existing system to the password of the new SMA device, reset the old system password (see Section 17.3, page 117).
9. Select and configure the new device.

## 11.3 Configuring the Sunny Home Manager

### Requirement:

- You must have the user role **Installer** or **PV System Administrator** (see Section 16.1, page 113).

### 11.3.1 Selecting Simple or Extended Configuration

When calling up the Device properties of the Home Manager the **Simple configuration** is shown. Here, you can make all default settings.

Under **Extended configuration** you can make further settings. Generally, configuration of the fields displayed in this view is only required during initial configuration of the Sunny Home Manager.

#### Selection of the Extended Configuration:

1. Call up the **Properties** under **Device overview** in the row of the Sunny Home Manager.
2. Select **[Edit]**.
  - In the **View:** line both options are now shown: **Simple configuration** (activated) and **Extended configuration**.
3. If you want to configure further functions, select **Extended configuration**.
4. Make the required settings and confirm with **[Save]**.

### 11.3.2 Setting Automatic Updates

If the automatic software update is activated, Sunny Portal regularly checks whether there are update files for the Sunny Home Manager or for the PV system devices. If there are update files, these are automatically downloaded and the devices are updated.

You can activate/deactivate the automatic software update for:

- Sunny Home Manager
- PV system devices

By default, the automatic software update is activated for the Sunny Home Manager and the devices in the PV system.

### 11.3.3 Enabling Speedwire Encryption

The Speedwire encryption lets you safely encrypt the local SMA system network with SEC (Speedwire Encrypted Communication) and protect from unauthorized access.

- i** The Speedwire encryption can only be enabled if all devices in the system support SEC (Speedwire Encrypted Communication) and the devices can be accessed by the Sunny Home Manager.

#### Procedure:

1. Call up the **Properties** of the SMA Home Manager.
2. Select **[Edit]** on the device tab.
3. In the line **Speedwire encryption** enable the field **Active**.
4. Click on **[Save]**.

- i** If a new device is integrated into the system, this device must support encryption so that the encryption of the system can be maintained. Speedwire encryption must be temporarily deactivated if a new encryption-capable device is not displayed in the **Overview of new devices**. Once the new device has been added to the system, encryption can be re-enabled.



- i** If the Sunny Home Manager is reset when Speedwire encryption is activated, the encryption is deleted and thus also the communication between the Sunny Home Manager and the Speedwire devices (see Section 11.7.1, page 66). Therefore, deactivate Speedwire encryption before resetting the Sunny Home Manager.

### 11.3.4 Configuring AVM FRITZ!Box Smart Home Control

The Sunny Home Manager communicates with FRITZ!DECT products such as radio-controlled sockets or thermostats only indirectly via the FRITZ!Box.

#### Requirements:

- You must have a FRITZ!Box with Smart Home software support.
- The FRITZ!Box must be equipped with the DECT function.
- The FRITZ!DECT products connected to the FRITZ!Box must have been correctly connected and commissioned (see manufacturer's manual).
- The radio-controlled sockets connected to the FRITZ!Box must be able to measure the energy consumption.
- You must be logged in to your FRITZ!Box with a user name and password. You should have this data ready, as the settings for the FRITZ!Box login must be the same in the home network and in the Sunny Home Manager.

#### Procedure:

1. In the menu **Configuration** select the **Device overview**.
  2. Select **Properties** in the row of the Sunny Home Manager.
  3. Select **[Edit]**.
  4. Go to **AVM FRITZ!Box Smart Home control** and select **Yes** under **FRITZ!Box Smart Home available**.
    - Further setting options open up.
  5. **i** **From the version FRITZ!OS 7.25 and the change in the system security of the AVM Fritz!Box, it is no longer possible to log in with a password only.**

A virtual user is automatically created in the FRITZ!Box with the name "fritzxxxx" (x = number between 0 and 9). This means that the connection data that allows the Sunny Home Manager to switch radio-controlled sockets on the Fritz!Box needs to be adapted accordingly in Sunny Portal.

Therefore, SMA recommends selecting **FRITZ!Box-Benutzer und -Kennwort** (FRITZ!Box user and password) when logging into the home network.

The setting "FRITZ!Box-Kennwort" (FRITZ!Box password) can now only be used for older systems.
  6. Under **FRITZ!Box login to the home network:** select the setting **FRITZ!Box user and password**.
  7. Under **FRITZ!Box address:** keep the default setting **fritz.box**, enter the IP address of the FRITZ!Box, or the IP address under which the user interface of your FRITZ!Box in your home network can be reached.
  8. Under **FRITZ!Box user:** enter the user name you entered to log in to your FRITZ!Box.
  9. Under **FRITZ!Box password:** enter the same password that you used to log in to your FRITZ!Box and repeat this under **Repeat:**.
  10. Click on **[Save]**.
    - After a few minutes, the FRITZ!DECT products appear in the **Overview of new devices** and can now be configured.
- i** If you have a FRITZ!DECT radio-controlled socket or a FRITZ!DECT thermostat, the ambient temperature of the device is displayed on menu page **Smart Home > Temperature**.

### 11.3.5 Configuring the display of the current status

The current status of the grid supply and the grid feed-in can be displayed via an LED lamp and thus support you in your load control:

- When the LED light is **green**, "surplus" PV energy is available, which the Sunny Home Manager could use to operate additional loads.  
You can increase your self-consumption quota by having additional loads managed by the Sunny Home Manager.
- When the LED light is **red**, the household is consuming more energy than is generated via PV. This additional demand is met by purchasing energy from the utility grid for a fee.

The LED lamp is not one of the maximum number of devices that can be controlled by the Sunny Home Manager, so it does not reduce its number.

**i** The Sunny Home Manager exclusively controls the color change of the LED lamp. The Sunny Home Manager does not perform on/off switching or dimming of the LED lamp or power measurement.

#### Requirement:

- For this AVM FRITZ!DECT 500 LED lamp, you need to use a FRITZ!Box with DECT as well as FRITZ!OS version 7.20. How to establish a DECT connection and set up the LED lamp can be found on the manufacturer's website at [https://avm.de/service/wissensdatenbank/dok/FRITZ-DECT-500/3541\\_FRITZ-DECT-500-im-FRITZ-Box-Heimnetz-einsetzen/](https://avm.de/service/wissensdatenbank/dok/FRITZ-DECT-500/3541_FRITZ-DECT-500-im-FRITZ-Box-Heimnetz-einsetzen/).

#### Procedure:

- Under **AVM FRITZ!Box Smart Home control**, in the line **Current status display via:**, select the previously commissioned LED lamp from the drop-down list.

### 11.3.6 Setting the Edimax Smart Plug

Now the password for the Edimax radio-controlled sockets can be entered in the device properties of the Sunny Home Manager:

- Enter the Edimax password.

All Edimax smart plug outlets in the system must have the same password. Otherwise the Edimax smart plug outlets may not be controlled by the Sunny Home Manager.

Ensure that the shared password is also entered in the Edimax app for each outlet.

### 11.3.7 Enabling System Communication Monitoring

In the area **System communication monitoring** you can only deactivate or activate monitoring of your system. In the other fields the current configuration of the communication monitoring is displayed.

#### Procedure:

1. In the main menu, call up the page **system monitoring**.
2. Click on the button **[Settings]**.
  - The tab **Configuration communication monitoring** opens.
3. Set the desired option (off / liberal / tolerant / sharp) using the slider under **Alerts**.
  - Under **Time** the associated time period is displayed after which an alarm may be issued.
4. Click on **[Save]**.

### 11.3.8 Setting the Data Request Interval

#### Requirement:

- You must have the user role **Installer** or **PV System Administrator** (see Section 1.6.1, page 113).

The data request interval defines how often the Sunny Home Manager sends data to and requests data from Sunny Portal.

Option	Explanation
automatically	The Sunny Home Manager updates data on the pages <b>Current Status and Forecast</b> and on the tabs <b>Current</b> within a few seconds. The Sunny Home Manager sends data that is displayed on other pages to Sunny Portal within a few minutes (up to a maximum of 15 minutes).
Hourly	The Sunny Home Manager sends data to and requests data from Sunny Portal hourly. Settings made via Sunny Portal are sent to the Sunny Home Manager within 60 minutes.
Daily	The Sunny Home Manager sends data to and requests data from Sunny Portal every 24 hours. Settings made on Sunny Portal are sent to the Sunny Home Manager within 24 hours.

**i** If loads are controlled via switching devices such as radio-controlled sockets or all-or-nothing relays, you must activate the **Automatic** option.

#### Procedure:

1. Call up the **Properties** of the Home Manager under **Device overview**.
2. Select [**Edit**].
3. Select [**Extended configuration**].
4. In the area **Data request interval**, select the desired option.
5. Click on [**Save**].

SMA Solar Technology AG only recommends setting the data request interval to **Hourly** or **Daily** if your Internet connection is established via a GSM modem. This way, depending on your GSM tariff, you will avoid additional costs.

## 11.3.9 Activating SMA Smart Home

### 11.3.9.1 Activating the Self-Consumption Function

If you want to use the self-generated PV energy in your household, the Sunny Home Manager system must be configured accordingly.

If you already answered **Yes** to the question about self-consumption when you created the system in Sunny Portal (see Section 9.1, page 30), you do not have to do anything.

If you have not yet made this specification when creating the system or if you want to subsequently set your system to self-consumption, you can make this setting either via the configuration of the Sunny Home Manager or via the configuration of the system.

#### Activating self-consumption via the Sunny Home Manager:

1. In the menu **Configuration**, click on **Device overview**.
2. Go to **Properties** in the row of the Sunny Home Manager.
3. Select [**Edit**].
4. Go to **SMA SMART HOME Settings** and select **Yes** under **System with self-consumption**.
5. Click on [**Save**].

#### Activating self-consumption in the configuration of the system:

1. Click on **System properties** in the **Configuration** menu.
2. Select the tab **Parameters**.
3. Select [**Edit**].

4. Go to **Reimbursement** and select **Yes** under **PV system with self-consumption**.
5. Click on **[Save]**.

### 11.3.9.2 Setting up Forecast-Based Battery Charging

Forecast-based battery charging is based on the production and consumption forecast of your smart home. The settings for charging a battery are only displayed for systems with a battery.

Setting	Explanation
Forecast-based battery charging	To create a battery-charging forecast for the next 48 hours, the Sunny Home Manager uses the current day and the two following days by default.
Required state of charge (SOC) in terms of forecast-based charging	<p>Disables the forecast-based charging until the battery is charged to the specified % value (SoC = State of Charge). If this value is reached, the Sunny Home Manager enables forecast-based battery charging function.</p> <p><b>This configuration may lead to derating losses.</b> The electricity generation and consumption forecast is not taken into account up to the entered value. The energy may be reduced if the battery does not have sufficient free capacity for storage.</p>
Charging of battery prior to optional loads	If you enable this function, the battery charge is prioritized over an optional load that you have defined.
Shortened forecast period	<p>Shortens the default forecast period to the current day. This allows more PV energy to be loaded into the battery on the current day.</p> <p><b>This configuration may lead to derating losses.</b> PV energy may have to be derated on the following days due to insufficient free battery capacity.</p>

#### Requirement:

- Strings must be configured in the system.
- At least 1 battery or hybrid inverter must be configured in the system.

#### Procedure:

1. Go to **SMA SMART HOME Settings** and select **Active** under **Storage management via the Home Manager**.  
Only select the option if active power limitation is configured in the system.
  - Another setting option opens.
2. Enter the required value under **Required state of charge (SOC) in terms of forecast-based charging**.
3. If the battery needs to be charged prior to a defined optional load, select **Active** under **Charging of battery prior to optional load**.
4. If the forecast period is to be shortened from 48 h to the current day, select **Active** under **Shortened forecast period**.
5. Click on **[Save]**.

### 11.3.10 Configuring the External Current Transformer

- This setting is only possible under **Extended configuration**.
- If the integrated measuring unit of the Sunny Home Manager is connected directly, it can measure a maximum current of 63 A per phase. Current transformers must be used to measure currents > 63 A per phase (see Section 8.2.3, page 26).

**Procedure:**

1. For the request **External current transformer:** click on **Yes**.
2. Enter the specified values of the current transformer (default setting: 1 each) in the fields **Primary current:** and **Secondary current:**.
3. Click on [**Save**].

### 11.3.11 Changing the Meter Configuration

In the **Meter configuration** area the data are displayed that were entered during commissioning and registration of the system (see Section 9.1, page 30)

- A change is only possible under **Extended configuration**.

#### **i** Only adjust the meter configuration for changes that are absolutely necessary

This might be the case, for example, if the grid operator demands a faster reaction for the dynamic active power limitation or for the zero feed-in (zero export). Contact your grid operator for information and observe the applicable standards and SMA manufacturer declarations.

**Procedure:**

1. Select [**Edit**] on the tab for the device setting of the Sunny Home Manager.
2. In the **Meter configuration** area in the fields **Supply and feed-in** as well as **PV power generation**, select the desired feed-in and grid-supply meter as well as PV generation meter from the drop-down list:
3. Select the desired measuring interval from the **Measuring interval internal energy meter** drop-down list. Do not change the default 1000 ms unless this is required by standards (see corresponding manufacturer declarations and unit certificates).  
Note: If the internal energy meter is not used as the meter, the measuring interval must be set directly on the meter used.
4. Enter the IP addresses of all devices (up to 3) that require this data (e.g. battery inverters, stand-alone inverters or hybrid inverters) in the input fields under **Direct meter communication** only if communication problems occur.  
Information: If an entry was made here, the meter telegram is no longer sent as a multicast telegram as before. This might cause problems with third-party devices.
5. Click on [**Save**].

### 11.3.12 Configuring Modbus Interfaces

- This setting is only possible under **Complex configuration**.

Each device that is to communicate with the Sunny Home Manager via a Modbus communication protocol must be uniquely addressed.

On the tab **Modbus configuration**, you can store up to 4 different Modbus configurations with which the Sunny Home Manager searches for connected devices. After a successful search, the detected devices appear on the tab **Overview new devices** and can be added there (see Section 11.2.2, page 54).

**Procedure:**

1. After selecting the **Extended configuration** view, open the tab **Modbus Configuration**.
2. In the **Modbus Profile** column, select the desired predefined Modbus device from the drop-down menu.
3. Enter the data of the selected device in the fields **IP address**, **Port** and **Unit ID**.  
If the Modbus device is a Moxa device, it is recommended to set the Moxa in the router with an IP address/MAC address binding or to subsequently set to a fixed IP address from the free range of the router not used for DHCP. Port (default 502) and Unit ID (default 1 or 2) do not need to be changed.  
Existing entries can be changed by overwriting.  
To **delete** a configuration, click on the recycle bin symbol  in the corresponding line.
4. Click on [**Save**].

## 11.4 Adding and Configuring the Inverter

### Requirement:

- You must have the user role **Installer** or **PV System Administrator** (see Section 16.1, page 113).

### 11.4.1 Adding an Inverter

#### Requirements:

- The new device must be in operation.  
Tip: Keep note of the serial number of the device you want to add.
- For the new SMA device, the default password **1111** for the user group **Installer** or the system password of the existing system must already be set (see Section 17.3, page 117).
- In the new device this must be set: **Data collection activated** (see Section 11.1.4, page 52).
- For the Sunny Home Manager this must be set: **Data request interval Automatic** (see Section 11.3.8, page 58).

#### Procedure:

1. Under **Configuration > Device overview** select the tab **Overview of new devices**.
2. Select device after preselection via the device filter or in the list and activate via .  
 The configuration wizard opens and provides the further procedure step by step.
3. Enter the device name. You can also select and edit one of the suggestions displayed.
4. Enter the **Phase** and **Generator power** in the device properties.
5. When required, activate inverter comparison and enter a percentage value for the tolerance in the system monitoring.
6. Select **[Next]**.  
 A summary of your entries is displayed.
7. If the data are correct, select **[Finish]**.  
 The new SMA device is displayed under **Configuration > Device overview**.  
It can take up to 20 minutes to replace an inverter using the configuration wizard.

### 11.4.2 Entering Line Conductors

Sunny Portal can display in the devices classes PV inverter and battery inverter the line conductor(s) to which each inverter is connected.

#### Procedure:

1. In the checkbox **Phase**, activate the line conductor(s) to which the inverter is connected.
2. Click on **[Save]**.

### 11.4.3 Entering the PV Array Power

The PV array power is the maximum power of the PV modules connected to one PV inverter.

You can calculate the PV array power via the string properties (see Section 10.2, page 40) or enter it manually.

SMA recommends calculating the PV array power via the string properties. A string describes a group of series-connected PV modules. Normally, a PV system is made up of multiple strings. Each string has specific properties, such as deviation to south (azimuth) or the roof tilt angle.

Entering the string properties provides the following advantages:

- Sunny Portal can determine the PV array power more precisely.
- The Sunny Home Manager can deliver more exact yield forecasts and control loads more efficiently.

You can find out the connected PV array power present on each inverter from your installer. Using the PV array power, Sunny Portal can calculate your nominal PV system power.

**i** **Nominal PV system power required for limiting active power feed-in**

You must enter the PV array power correctly to ensure limitation of the active power feed-in to the correct value. If there are changes to the installed PV array power, you will need to adjust this value.

**Procedure:**

1. In the area **Generator capacity**, enter the PV array power in the field **kWp**.
2. Click on [**Save**].

## 11.5 Adding a Switching Device

### 11.5.1 Adding a Radio-Controlled Socket

**Requirements:**

- The new device must be in operation.
- For the Sunny Home Manager this must be set: **Data request interval Automatic** (see Section 11.3.8, page 58).

**Procedure:**

1. Under **Configuration > Device overview** select the tab **Overview of new devices**.
2. Select device after preselection via the device filter or in the list and activate via **+**.
  - The configuration wizard opens and provides the further procedure step by step.
3. Enter the device name. You can also select and edit one of the suggestions displayed.
4. Select [**Next**].
5. In the drop-down list select the **Load** that is connected to the radio-controlled socket.  
If the desired load is not available, select **No assignment** and then add the new load for this radio-controlled socket later.
6. Select [**Next**].
  - A summary of your entries is displayed (see the following example).
7. If the data are correct, click on [**Finish**].
  - You are automatically forwarded to the tab **New load** of the configuration page **Load overview and planning** to configure the new load.

**1**  
Device Name

**2**  
Device Characteristics

**3**  
Summary

### Edimax Smart Plug - PV System Extension



**Serial Number:**

Wenn die Daten richtig sind, wählen Sie "Fertigstellen".

**Device Name:** Edimax 7B1

**Load:** No assignment

« Back
Cancel

Finish

Figure 12: System extension with radio-controlled socket (example)

Detailed information on the configuration of new loads can be found under **Load overview and planning** (see Section 12.2, page 72).

**i** FRITZ!DECT radio-controlled sockets automatically measure the ambient temperature near the device. The temperature is displayed on the menu page **Smart Home > Temperature**.

## 11.5.2 Adding Modbus Device

### Requirements:

- The new device must have been installed in the system and commissioned in accordance with the manufacturer specifications.
- The **Modbus configuration** must have been performed on the Sunny Home Manager (see Section 11.3.12, page 61).
- For the Sunny Home Manager this must be set: **Data request interval Automatic** (see Section 11.3.8, page 58).

### Procedure:

1. Under **Configuration > Device overview** select the tab **Overview of new devices**.
2. Select device after preselection via the device filter or in the list and activate via **+**.
  - The configuration wizard opens and provides the further procedure step by step.
3. Enter the device name. You can also select and edit one of the suggestions displayed.
4. Select **[Next]**.
5. In the drop-down list select the **Load** that is connected to the Modbus device.
  - If the desired load is not available, select **No assignment** and then add the new load later.
6. Select **[Next]**.
  - A summary of your entries is displayed.
7. If the data are correct, click on **[Finish]**.
  - You are automatically forwarded to the tab **New load** of the configuration page **Load overview and planning** to configure the new load.

Currently only one load can be switched per one Modbus device.



## 11.6 Adding direct communicating loads

The Sunny Home Manager can include loads that support either the EEBus data exchange protocol or the SEMP data exchange protocol in the energy management system.

While SEMP devices such as the SMA EV Charger are automatically connected and displayed, EEBus devices must be actively paired.

### 11.6.1 Pairing Loads via EEBus

- This setting is only possible under **Complex configuration**.

**i** Only selected loads support the connection to the Sunny Home Manager via EEBus (see technical information "SMA SMART HOME - Compatibility List for the Sunny Home Manager 2.0").

The following steps are required for pairing the devices:

- Activating EEBUS
  - Activate EEBus protocol on Sunny Home Manager.
  - Activate EEBus in the loads (see manufacturer's manual).
- Pairing EEBus devices
 

This pairing must be performed separately for each individual load.

  - Pair the Sunny Home Manager to the load via EEBus.
  - Pair the load with the Sunny Home Manager via EEBUS (see manufacturer's manual).

#### Requirements:

- The Sunny Home Manager and the loads must be operational and connected to each other via a router in the same local network.
- Some loads require that the security key "SKI" (Subject Key Identifier) of the Sunny Home Manager is known when pairing. You can find the SKI device identifier of the Sunny Home Manager in Sunny Portal in the **Device overview** in the **Properties** on the **Parameters** tab of the Sunny Home Manager under EEBUS SKI device identifier.

#### Activating the EEBus Protocol

By activating the EEBus protocol, you enable devices with an EEBus interface to connect to the Sunny Home Manager. For more information on the EEBus protocol, please see <https://www.eebus.org/>

#### Procedure:

1. Call up the **Properties** of the Home Manager under **Configuration > Device overview** in Sunny Portal.
2. Select [**Edit**] on the device tab.
3. In the View line, select **Complex configuration**.
4. Go to **SMA SMART HOME Settings** and select **Active** under **EEBUS protocol**.
5. Activate EEBus in the loads (see manufacturer's manual).

#### Pairing EEBus devices

A time window of 2 minutes is available for pairing the devices.

#### Procedure:

1. In the Sunny Home Manager, in the **EEBUS protocol** line, click on the info text → **Pairing EEBUS loads?** and confirm the pairing in the pop-up window that opens with [**Pairing**].
2. Then initiate pairing at the load within 2 minutes (see manufacturer's manual).

3. In the case of the load, add the Sunny Home Manager as a known EEBus device. When prompted, enter or confirm the SKI device identifier of the Sunny Home Manager.
  - The new load is displayed at **Device Overview > Overview of New Devices** in Sunny Portal.
4. Add the new load to the system (see Section 11.2.2, page 54).
  - The new load is automatically displayed on the page **Load Overview and Planning**.  
If necessary, you can use the  button to open the **Load characteristics** page and make further settings.

## 11.7 Replacing the Sunny Home Manager

 If you need to replace the Sunny Home Manager, you must use the system setup assistant (see Section 9.1, page 30).

### Requirements:

- You must have the user role **Installer** or **PV System Administrator** (see Section 16.1, page 113).
- The Sunny Home Manager to be replaced must have been decommissioned (see Section 19.1, page 133).
- The new Sunny Home Manager must be reset prior to the replacement:
  - Ex works (new device)
  - Manually (already used device)
- The new Sunny Home Manager must have been commissioned:
  - The new Sunny Home Manager must be connected to the router (see Section 8.3.2, page 27).
  - The new Sunny Home Manager must be supplied with voltage (see Section 8.2, page 24).
- The serial number and the registration ID of the new Sunny Home Manager are available. These data can be found on the type label attached on the side of the device or on the label provided.

### Procedure:

1. Log in to the Sunny Portal system setup assistant and enter the access data (see Section 9.1, page 30).
2. Select **[Next]**.
  - The page **Select PV system** opens.
3. Activate the field **Add or replace devices**.
4. Select  in the line of the Sunny Home Manager system for which you want to replace the Sunny Home Manager.
5. Select **[Next]**.
  - The page **Select devices** opens.
6. Enter the identification key of the Sunny Home Manager in the field **PIC**. Enter the registration ID of the Sunny Home Manager in the field **RID**.
7. Select **[Identify]**.
  - Sunny Portal checks whether the identification key and registration ID correspond to the connected Sunny Home Manager.
8. If the system setup assistant does not find a Sunny Home Manager with this information, rectify the error (see Section 18, page 119).
9. Select **[Next]**.
10. Select **[Finish]**.

### 11.7.1 Resetting the Sunny Home Manager

A Sunny Home Manager must only be reset if it had been installed in another system previously.

### **i** Loss of data due to replacement or due to resetting to default settings

If the Sunny Home Manager is reset to the default settings, all data saved in the Sunny Home Manager will be deleted. The data saved in Sunny Portal can be transmitted to the Sunny Home Manager after calling up the PV system again in Sunny Portal. Devices that were paired to the Sunny Home Manager via EEBus have to be paired again.

#### **Reset to default setting**

1. Hold down the reset button with a pointed object until the LEDs flash red. This can take from 2 to a maximum of 6 seconds.

Pressing down and holding the reset button for less than 2 seconds has no effect.

If the reset button is held down for longer than 6 seconds, the Sunny Home Manager is restarted (see Section 11.8, page 68).

The LEDs flash first green and then red.

2. As soon as the LEDs flash red, release the reset button.

All data stored in the Sunny Home Manager is deleted and the Sunny Home Manager restarts.

### **11.7.2 Reassigning the Sunny Home Manager to the Sunny Portal System after the Reset**

If you have performed a complete reset of the Sunny Home Manager, you must reassign the Sunny Home Manager to your Sunny Home Manager system in Sunny Portal. Otherwise, Sunny Portal will not accept any data from the Sunny Home Manager.

When you log in the portal after resetting the Sunny Home Manager, a notice is shown automatically stating that the Sunny Home Manager has been reset. You will be asked whether you want to reassign the Sunny Home Manager to the system.

#### **Requirement:**

You must have the user role **Installer** or **PV System Administrator** (see Section 16.1, page 113).

#### **Procedure:**

1. Open **www.sunnyportal.com** and select **System setup assistant**.

or

Go to **www.sunnyportal.com/register**.

The system setup assistant opens.

2. Select [**Next**].

The page **User registration** opens.

3. Activate the checkbox **I am already registered in Sunny Portal**.

4. Enter the e-mail address and the Sunny Portal password in the fields **E-mail address** and **Password**.

5. Select [**Next**].

The page **Select PV system** opens.

6. Activate the field **Add or replace devices**.

7. In the line of the Sunny Home Manager system to which you would like to reassign the Sunny Home Manager, select .

8. Select [**Next**].

The page **Select devices** opens.

9. Enter the identification key of the Sunny Home Manager in the field **PIC**. Enter the registration ID of the Sunny Home Manager in the field **RID**. Tip: You can read off the identification key and the registration ID from the type label on the side of the Sunny Home Manager or from the supplied label.

10. Select [**Identify**].
11. Select [**Next**].
12. Select [**Finish**].

## 11.8 Restarting the Sunny Home Manager

A restart of the Sunny Home Manager is only necessary as a result of a corresponding error message (see Section 18, page 119).

### Procedure:

1. Call up the Properties of the Home Manager under **Configuration > Device overview** in Sunny Portal.
  2. Select [**Edit**] on the device tab.
  3. Activate the option **Complex configuration**.
  4. In the upper text block in the line **Product group**: click the field → **Restart** and in the pop-up window that opens activate the execution via the button [**Restart**].
- The system reports the successful initiation of the restart. The restart is carried out automatically.

Alternatively, you can also perform a restart directly on the device:

- Hold down the reset button on the Sunny Home Manager with a pointed object until the LEDs stop flashing red (at least 6 seconds).  
If you press and hold the reset button for less than 6 seconds, the Sunny Home Manager is reset to default settings and all data stored in the Sunny Home Manager is deleted (see Section 11.7.1, page 66).
- LEDs go out. The status LED then glows red constantly during system startup.

## 11.9 Deleting devices from Sunny Portal

### **i** Device data is irretrievably deleted

If you delete a device, all the data of that device is irretrievably deleted.

- Check whether it is sufficient to deactivate the device.

### Requirement:

- You must have the user role **Installer** or **PV System Administrator** (see Section 16.1, page 113).

### Procedure:

1. Select the device properties of the device.
  2. Select [**Edit**].
  3. Select [**Delete**].
- A window with a security prompt opens.
4. To irretrievably delete the device, select [**Delete**].

## 12 Load Control

### 12.1 Background Information

#### 12.1.1 Types of Loads

A load is a device in a household that is operated with electrical energy.

The goal of the open-loop control is to have the Sunny Home Manager switch the load so that PV energy is mostly used, if possible, and thereby, or by selecting a suitable time window, minimize the energy costs for operating the load.

Loads suitable for control by the Sunny Home Manager are those that are to be switched on and operated for a defined period of time (e.g. washing machine) or have a flexible time of use (e.g. heat pump, charging station for electric vehicles).

Loads that are only switched on when they are needed immediately afterwards (e.g. television, toaster, lamp, or vacuum cleaner) are not suited for being controlled by the Sunny Home Manager.

A distinction is made between the following types of loads that are suited for being controlled by the Sunny Home Manager:

- Indirectly communicating loads that are integrated via switching devices:
  - Program-controlled loads
  - Non-program-controlled loads
- Directly communicating "intelligent" loads

#### Loads controlled by switching devices

##### Program-controlled loads

A program-controlled load runs through a preset program during operation. The program is typically selected by the user prior to operation and started by pressing the start button on the load. Once the program has started, the load should no longer be switched off.

Sunny Home Manager can only control a program-controlled load if, after an interruption in the power supply, the load's program picks up at the point where the power supply was interrupted.

Typical program-controlled loads include washing machines, dishwashers and clothes dryers.

##### Non-program-controlled loads

The load must be able to switch on and off as needed and have a flexible switch-on time.

The Sunny Home Manager can select one or more periods within the user-defined time frame in which it can switch the load on or off.

Typical non-program-controlled loads include heating rods in hot water storage tanks, pool pumps, or charging stations for electric vehicles.

##### Directly communicating loads

Directly communicating loads exchange their data directly with the Sunny Home Manager via an SEMP or EEBus interface. The exchanged data can change several times a day depending on the needs of the load. In comparison to a self-configured indirectly communicating load, directly communicating loads offer you better system efficiency and a higher potential for savings.

The load connected via Ethernet or Wi-Fi sends the Sunny Home Manager information about the load type, the planned energy requirement, and the preferred operating time period. The Sunny Home Manager factors this information into its load planning, takes the configured optimization targets for the load control into account, and sends the appropriate start and stop signals to the load.

As soon as this load has been added to your Sunny Home Manager system and configured once, you do not need to make any further settings.

### 12.1.2 Communicating with Loads

To have loads captured and controlled by the Sunny Home Manager, you must establish a connection between the load and Sunny Home Manager:

- Via radio-controlled sockets/relays as intermediate switches (not directly communicating loads)
  - Capturing the energy consumption of individual home appliances: measuring function of the assigned radio-controlled socket
  - Controlling household appliances: on/off function of the assigned device
- Via the standard protocol interfaces (directly communicating loads)

#### Measuring and switching

If a load is connected to the Sunny Home Manager via a switching device with a measuring function, this switching device can measure the energy consumption of the connected load and transmit it to the Sunny Home Manager. For this purpose, the switching device must be assigned to the Sunny Home Manager system.

The Sunny Home Manager system can switch loads connected to the switching device on and off.

If a load is not assigned to a switching device, the Sunny Home Manager does not receive consumption data from this load and it cannot control this load (see Section 12.4.8, page 81).

A load can either be permanently connected to the same switching device or to alternate switching devices. For each change, the load must be assigned to the new switching device.

Since the Sunny Home Manager does not receive any detailed data on loads if they are controlled via switching devices, you will need to make additional settings in the load profiles depending on the respective load type (see Section 12.4.2, page 79). Thus, the Sunny Home Manager can effectively schedule the loads and help save energy and costs.

#### Direct communication of devices using data exchange protocols

This connection option is only possible for smart appliances which communicate with the Sunny Home Manager via a data exchange protocol such as EEBus or SEMP (see Section 12.6, page 86).

Since the load transmits all information about its energy demand and consumption directly to the Sunny Home Manager and exchanges this information with it automatically, you cannot configure a directly communicating load yourself.

### 12.1.3 Controlling Loads via a Time Period

You can configure time periods for loads that communicate with the Sunny Home Manager via a switching device. Within these time periods, the Sunny Home Manager automatically switches loads on and off. You cannot make any settings in Sunny Portal for loads that communicate directly. All necessary information can be exchanged directly if the directly communicating load has been configured according to the manufacturer's specifications.

The configuration differentiates between the following types of time periods:

- Load **MUST** be switched on
- Load **CAN** be switched on

#### Load **MUST** be switched on

The load must have a defined operating time.

Sunny Home Manager switches the load on and off within the configured time period.

You should select this option if the load should be operated in any case, for example on a specific day.



The load is also switched on if there is not sufficient self-generated PV energy available, i.e. energy required for the load to operate may be drawn from the utility grid.

## Load CAN be switched on

You can only select this option if you have a self-consumption system and use the self-generated PV energy in your own household.

The load must have a flexible switch-on time. The Sunny Home Manager switches on the load within the time period you have configured. However, the configured conditions must be met. You choose among the following conditions for configuration:

### Proportion of the PV energy

You can set the load to be switched on only when a certain minimum amount of PV energy is available for its operation or is expected for a certain period of time (ecological optimization).

- **0% PV generation** = 100% grid-supplied power

Since grid energy is always available, the load can be operated within the time period without any restrictions. However, this selection does not make sense, as self-consumption systems should aim for the highest possible self-sufficiency quota.

- **100% PV generation** = 0% grid-supplied power

The load is switched on only if its operation can be covered by the PV power surplus. Since you directly use the energy generated by your PV system yourself, it is not fed into the utility grid and you do not receive any feed-in tariff for this PV energy.

- **100% surplus PV energy**

If the limiting of the active power feed-in (see Section 10.4.3, page 43) is activated, you can also set the proportion of surplus PV energy that would otherwise be derated.

If your system has active power limitation, active power can only be fed into the utility grid up to a predefined threshold (e.g. 70% regulation in Germany). If this value is exceeded, the PV and hybrid inverters will be regulated down. As a result, any PV energy generated above this threshold is lost as "surplus PV energy". Surplus PV energy, however, can be used effectively if it is available when a load happens to be switched on. The surplus PV energy is free (0 ct/kWh) since it would not have been fed into the utility grid anyway due to the active power limitation requirements.

Sunny Home Manager considers surplus PV energy in its PV power generation forecast. If 100% surplus PV energy is set, the load will only be switched on if the forecasted surplus PV energy can cover the total power consumption for the configured minimum switch-on time.

### Maximum permitted energy costs

You can specify that the load should only be operated if the energy costs to operate the load are below a predefined cost limit (economic optimization).

- In the case of **exclusive use of energy from the utility grid**, the costs correspond to the electricity tariff in Euro/kWh for the grid-supplied electricity that was set in the system properties.

Since grid energy is always available, the load can be operated within the time period without any restrictions.

- In the case of **exclusive use of self-generated PV energy**, the costs correspond to the feed-in tariff in Euro/kWh that was set in the system properties.

You do not receive a feed-in tariff for PV energy if it is consumed by a load in your home instead of being fed into the utility grid. Put another way, the PV energy that could otherwise have been fed into the grid "costs" as much as the feed-in tariff.



If the set proportion of PV energy is not attained or the set maximum permissible energy costs are exceeded, it is possible that the load will not receive any energy and that the load will not be switched on at all in the defined time period.

### 12.1.4 Prioritizing Loads

In the case of loads that can be operated flexibly in terms of time, you can specify a sequence that the Sunny Home Manager will use to schedule these loads in its energy management. This prioritization can save you energy costs.

The prioritization will only be considered for the following loads:

- Loads connected to switching devices for which you have set time periods of type **Load can be switched on**.
- Batteries, if **Battery charging before optional loads** is enabled in the SMA Smart Home settings of the Sunny Home Manager (see Section 11.3.9.2, page 60).
- Smart appliances with optional energy absorption. You will have already set the priority of these devices when adding them to your Sunny Home Manager system via the configuration wizard.

#### Effects of prioritization:

- If there are several loads with CAN time periods, the lowest-cost energy will be allocated to the load which you have given the highest priority using the slider.
- If there is not enough low-cost PV energy for all loads with CAN time periods, lower-priority loads may not be switched on at all. For this reason, the priority of appliances with low power, such as washing machines and dishwashers, should be lower than the priority of charging devices such as the SMA EV Charger, for example.
- Basically, the Sunny Home Manager schedules optional loads only if it can ensure that the planning target is met. If the slider is set to 100% PV generation, it is possible that optional loads cannot be scheduled for use on cloudy days because minimum grid-supplied power cannot be excluded.

In the case of the time period type **Load must be switched on**, the priority of the load does not have any effect, as the load is switched on in any event, possibly also with grid-supplied power.

## 12.2 Load Overview and Planning

This menu page is divided into two areas:

- **Load overview** - shows the loads that are configured for use with Sunny Home Manager. You can view and change the configuration at any time or add new loads.
- **Load planning** - provides a graphical overview of the scheduled time periods in which the active loads must be operated (dark-colored bar) or can be operated (light-colored bar). Loads with direct communication are not listed here.



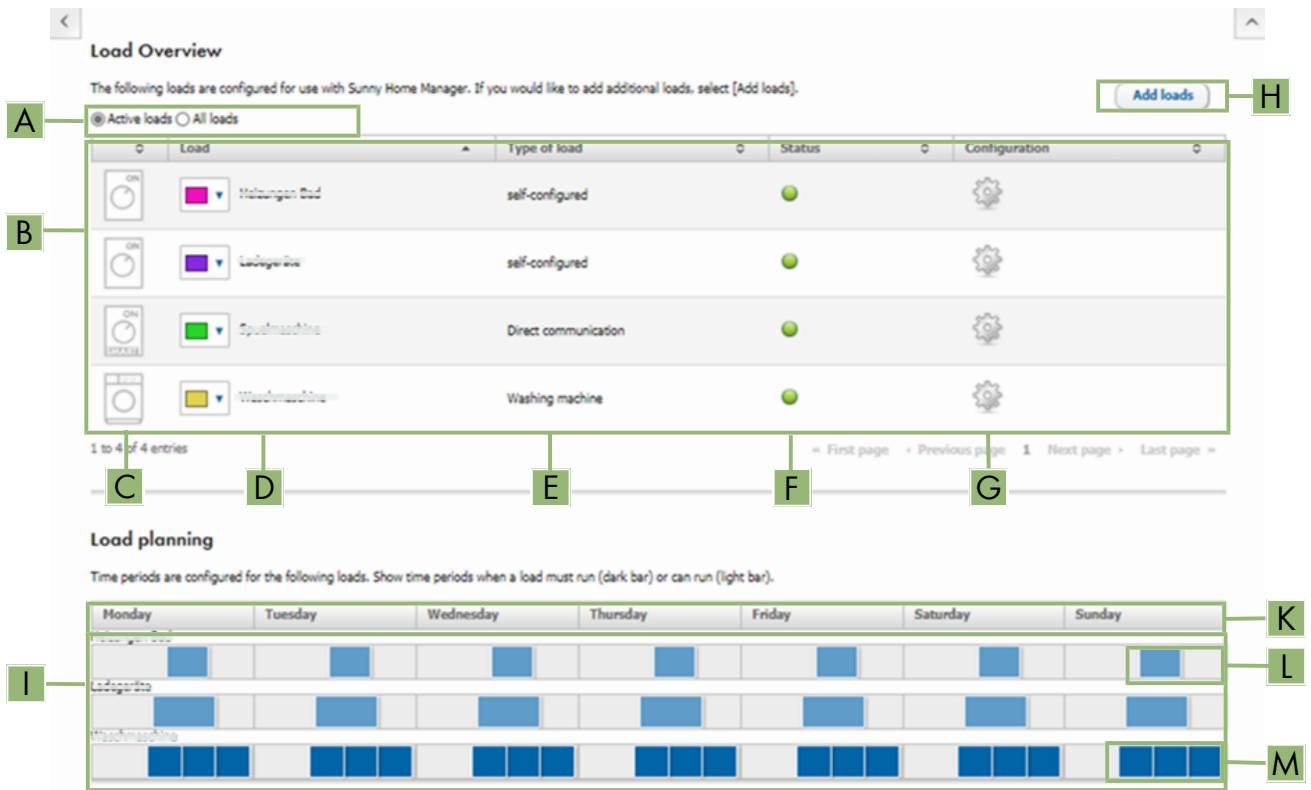

Figure 13: Load overview and planning (example)

Position	Designation	Explanation
A	Filter options	Using the filter options, you can filter the list of loads. Selecting the option <b>Active loads</b> will hide the loads that are currently not assigned to a switching device and therefore not controlled by the Sunny Home Manager.
B	Load list	List of loads which have been configured for use with the Sunny Home Manager.
C	Load icon	Symbol of the load
D	Name of load	Name of the load with assigned color A new color can be selected from the color palette.
E	Type of load	Type of the load
F	Status	Status of the load ● = OK The load is fully configured and can receive data. ○ = Not active Load is not assigned to a switching device. ? = Load is not fully configured
G	Configuration	Opens the tab <b>Name of Load</b> , on which you can configure the load properties.

Position	Designation	Explanation
H	Add loads	Using this button, you can add further loads to the Sunny Home Manager system. Smart appliances are recognized automatically by the configuration wizard and are displayed under <b>Device overview &gt; Overview of new devices</b> . Following successful registration, the devices are displayed on the page <b>Load Overview and Planning</b> in the area <b>Load Overview</b> .
I	Loads with time period setting	Only loads are shown here for which time periods were configured (see Section 12.5, page 83). Loads directly communicating with the Sunny Home Manager are not shown here.
K	Weekdays	For each individual weekday time periods can be configured for the loads.
L	Configuration: CAN time period (light blue)	Can only be configured in systems with self-consumption The load will only be switched on during the time period if certain conditions have been met.
M	Configuration: MUST time period (dark blue)	The load will always be switched on during the time frame.

## 12.3 Configuring Switching Devices

### 12.3.1 Safety when Configuring Switching Devices

#### ⚠ WARNING

##### Danger to life by switching medical devices

Unintentional switching of medical devices can result in life-threatening situations.

- Do not connect any medical devices to the switching device (e.g. radio-controlled socket/relay).

#### ⚠ WARNING

##### Risk of injury and fire due to unintentional and unattended switching on of loads

Loads that are switched on via a radio-controlled socket or a relay unintentionally and while unattended can cause injuries and fires (e.g. an iron).

- Do not connect any loads to the switching device that could endanger persons or cause damage if unintentionally switched on.

#### NOTICE

##### Damage to loads due through frequent switching

Frequently switching a load on and off can damage it.

- Ask the load manufacturer whether the load is suitable for control via a radio-controlled socket or relay, for example.
- Configure the switching device so that the load connected is not switched on or off more frequently than specified by the load manufacturer.
- Do not connect any loads to a switching device if they require a continuous current supply.

### 12.3.2 Requirements for Configuring Switching Devices

- The switching device must have been commissioned and registered in Sunny Portal (see Section 11.2.2, page 54).
- For the Sunny Home Manager this must be set: **Data request interval Automatic** (see Section 11.3.8, page 58).

### 12.3.3 Assigning a Load

In order that the switching device can be controlled by the Sunny Home Manager, you must assign a load to it. You will first need to create a load profile for the load (see Section 11.1.2, page 51). If have commissioned a switching device and have installed it without assigning a load in Sunny Portal, you can assign this switching device to the required load later on when you create the load profile.

#### Procedure:

1. Select **Configuration > Device overview** in the page and menu selection.
2. Call up the properties  of the desired switching device.
  - The menu for setting the device properties opens.
3. Select [**Edit**].
4. Select the connected load from the drop-down list **Loads**.
5. Click on [**Save**].

### 12.3.4 Entering the Device Name

Using the device name, you can identify the device assigned to the load in the Sunny Home Manager system. The more specific the information (e.g. radio-controlled socket, washing machine, cellar), the easier it is to differentiate between different devices or loads.

#### Procedure:

- In the text field **Device name**, enter the desired device name.

### 12.3.5 Configuring the Operating Mode

#### Requirements:

- The switching device must be assigned to the connected load (see Section 12.3.3, page 75).
- In Sunny Portal, the data request interval must be set to **Automatic** (see Section 11.3.8, page 58).

The following table lists and explains the operating modes you can select from:

Operating mode	Explanation
<b>Switch on</b>	No control of the switching device by the Sunny Home Manager The switching device is switched on and switches to the operating mode <b>On</b> . The connected load can draw electric current.

Operating mode	Explanation
<b>Switch off</b>	No control of the switching device by the Sunny Home Manager The switching device is switched off and switches to the operating mode <b>Off</b> . The connected load cannot draw electric current.
<b>Automatic</b>	Control of the switching device by the Sunny Home Manager The switching device switches to the operating mode <b>Automatic</b> . The Sunny Home Manager now considers the PV generation forecast for the PV system and the consumption behavior in the household and determines when the switching device, and thus the connected home appliance, is switched on within the configured time period. This operating mode cannot be set for the load type <b>Measure only</b>

**Procedure:**

1. In the page and menu selection, select **Sunny Home Manager System > Load Balance and Control**.
2. Select either the **Current** tab or the **Control** tab.
3. In the table, in the column **Operating mode**, select the button for the desired operating mode next to the required load.

You can also set the operating mode of the switching devices via the app.

### 12.3.6 Enabling Start-up Detection for Radio-Controlled Sockets

Start-up detection can only be activated for a load that is connected via a radio-controlled socket. Start-up detection is only possible if the power consumption of the load exceeds a specific minimum threshold (measurement tolerance).

The start-up detection is linked to the settings of the operating mode.

By enabling start-up detection, you enable the Sunny Home Manager to independently switch to the **Automatic** operating mode and to run the program of a load at the most favorable time possible within the configured time period.

Via the radio-controlled socket assigned to the load, the Sunny Home Manager uses the power consumption to detect when the connected load starts a program and switches the load off again directly via the radio-controlled socket in order to switch it on again later and automatically via the radio-controlled socket.

Sunny Home Manager blocks start-up detection for the duration of the load's maximum program operating time (blocking period) so that the program can run without a new interruption even when there are fluctuations in the power consumption of the load (e.g. 2nd start-up of a washing machine during the spin cycle). The information (that the start-up detection is temporarily disabled) is displayed in the Load balance and control menu under the Current tab. You specify the maximum program runtime when configuring the load (see Section 12.4.5, page 80).

**Requirements:**

- The load must be connected to the energy management system via a radio-controlled socket compatible with the Sunny Home Manager.
- The load must be a **dishwasher, washing machine** or **self-configured** (see Section 12.4.2, page 79).
- The load must be **program-controlled** (see Section 12.4.3, page 79).
- In order to enable start-up detection, the radio-controlled socket must be in the operating mode **Switched on** as an assigned device (see Section 12.3.5, page 75).

**Procedure:**

1. Select **Configuration > Load Overview and Planning** in the page and menu selection.
2. In the line of the desired load, in the column **Configuration**, select the symbol .
3. Select **[Edit]**.

4. In the field **Start-up detection**, select the checkbox **Active**.
5. If necessary, adjust the preset limit values in the text fields **Power limit for detection** and **Detection time**. These limit values must be exceeded so that an exit from standby mode or a load start-up can be detected.
6. Click on **[Save]**.

### **i** **Directly starting a load**

If you want the load to start directly by bypassing the automatic control of the Sunny Home Manager, the operating mode of the radio-controlled socket must be switched on manually (in Sunny Portal, e.g., via the page **Load balance and control > Current > Switch On**, via the Sunny Portal app, or by pressing the button on the radio-controlled socket). The load can then be started immediately. At the same time, start-up detection is disabled in the radio-controlled socket for a period of 3 hours so that the Sunny Home Manager cannot detect this start when start-up detection is switched on and cannot interrupt the program of the load.

After the blocking time has elapsed, the Sunny Home Manager takes over control again. This does not require changing the operating mode again.

## 12.4 Configuring Load Characteristics

- i** Depending on the load, you will be shown different input screens; all entries are load-specific.
- i** As soon as a load has been configured, only the general information can be changed. In order to change a load's configuration once made, the relevant load must be deleted and reconfigured.

You can set most of the inputs for configuring a load according to a common principle.

### **Procedure:**

1. In the page and menu selection, select either  
**Configuration > Load overview and planning**  
or  
**Sunny Home Manager System > Load Balance and Control**.
  - This opens the table showing the loads integrated in your system.
2. In the line of the desired load, select the Configuration symbol.
  - This opens the **Load characteristics** page.

## Load characteristics













Type of Load:	Washing machine 	
Programmability:	<input checked="" type="radio"/> Yes <input type="radio"/> No	
Name of Load:	<input type="text"/>	
Power Consumption:	<input type="text" value="1000"/> W 	
Max. Program Operating Time:	<input type="text" value="150"/> min	
Priority of the load:	<div style="display: flex; justify-content: space-between;"> <span>low</span> <span>high</span> </div> <div style="text-align: center;">   </div>	
Device assignment:	Waschmaschine  	
After operation of the load, the assigned device is:	On 	
Measuring and switching:	The assigned device is to measure and switch (intelligent power consumption) 	
Start-up detection:	<input checked="" type="radio"/> Active <input type="radio"/> Inactive	
Power threshold for detection:	<input type="text" value="7"/> W	
Detection time:	<input type="text" value="5"/> s	
Load icon:	 	
Load color:	 	



Figure 14: Example of a program-controlled load

### 12.4.1 Entering general information

Regardless of whether you want to configure a new or an already existing load, the tab (new load or name of the load) with the **Load properties** opens when the configuration is called.

In order to configure a new load, you should enter the following general information:

General properties	Explanation
Name of load	<p>Using the load name, you can identify the load and the switching device assigned to the load in the Sunny Home Manager system.</p> <ul style="list-style-type: none"> <li>Enter a load name in the <b>Name of Load</b> text field, e.g. <b>Washing machine basement</b>. The load name can have a maximum of 24 characters.</li> </ul>

General properties	Explanation
Load icon	<p><b>Select load icon:</b></p> <ul style="list-style-type: none"> <li>Select the desired load icon from the drop-down list to use a standard load icon.</li> </ul> <p><b>Upload load icon</b></p> <ul style="list-style-type: none"> <li>At the bottom of the page select [<b>Upload load icon</b>].</li> <li>Select the desired file (permitted file formats: JPG, JPEG, PNG, GIF, BMP).</li> <li>Click on [<b>Open</b>]. The file is uploaded and then displayed in the drop-down list <b>Load icon</b> as the selected new load icon.</li> <li>Select [<b>Save</b>].</li> </ul>
Load color	<ul style="list-style-type: none"> <li>Select the desired color from the drop-down list.</li> </ul>

## 12.4.2 Selecting the Load Type

Depending on the selected load type, you can display and configure different load properties on the tab. A preconfigured load profile is stored for some load types. If you select such a load type, some settings are not configurable.

Type of load	Explanation
Self-configured	<p>You configure the connected load individually. With this type of load, you must also state whether the load is program-controlled or if its operation can be interrupted at any time.</p> <p>Example of program-controlled load: dryer</p> <p>Example of load where operation can be interrupted: pond pump</p>
Direct communication	<p>The load is connected via network cable or WLAN to the local network in which the Sunny Home Manager is also located. Thus, the load can automatically send information on its energy requirement and consumption to the Sunny Home Manager and it can also receive switch-on and switch-off commands from the Sunny Home Manager.</p> <p>You do not need to make any configuration settings in Sunny Portal. If necessary, settings must be made on the product itself in accordance with the manufacturer's instructions.</p>
Energy monitoring (measuring only)	<p>Only the power consumption of the connected load is to be measured. (e.g. radio-controlled socket devices that permanently consume electric current, such as a refrigerator or devices in standby mode)</p>
Washing machine Dish washer Stiebel Eltron WWK 300/ WWP300 Tecalor TTA 300 heating element Heat pump SG Ready	<p>A preconfigured profile is stored for these loads.</p> <p>Some settings (e.g. program controllability) are blocked because they are not configurable for the relevant device.</p> <p>You can use the preconfigured profile or configure the device yourself.</p>

## 12.4.3 Selecting Program Controllability

- This option is only adjustable for the load type **Self-configured**.

You must make this setting directly when adding the load and specify whether the load must run predefined programs or not:

Setting	Explanation
Yes	After the start, the load runs through a defined program. Interrupting the load during the course of the program can affect the operation result and should therefore be avoided. (Examples: washing machine, dryer)
No	The load always runs when an electric current is present and always carries out the same function during operation. Multiple switching on and off per day does not cause any problems. The load does not have to run permanently - as long as a minimum operation time per day is achieved, interruption of operation has no negative effect on the function being carried out. (Examples: pond pump, heating element, water heater)

Once the setting has been made, it cannot be changed. If you want to change the information, you must delete the load and add it again.

### State of the Assigned Switching Device after Load Operation

This information is coupled with the program controllability and cannot be changed.

You see the following settings:

- If the load is program-controlled: switched on
- If the load is not program-controlled: switched off

Upon expiry of the set time period, the load remains in operation until the previously set target value (e.g. target temperature for a heat pump) is reached. You must set the target value directly on the load (see manual for the load).

#### 12.4.4 Entering the Power Consumption

The power consumption is the power (medium watt amount) typically required by a load for operation (see type label or load manual).

The Sunny Home Manager takes account of this value in the initial calculation of the required energy.

Once the load provides measured values of its actual consumption during operation, the Sunny Home Manager can determine a more precise power value after a learning phase. This way, the Sunny Home Manager gradually improves its load planning and increases energy and cost savings.

#### Procedure:

- Enter the power of the load connected in the text field **Power Consumption**.

#### 12.4.5 Entering the Maximum Program Operating Time

- This option can only be set for **program-controlled** loads.

The maximum program runtime is the time that a program-controlled load requires for its longest program. The maximum program operating time defines the latest time at which a load must be switched on so that its longest program can be completed within the specified time limits.



#### Maximum program operating time for a washing machine

You have defined a time slot from 10:00 a.m. to 6:00 p.m. for your washing machine (see Section 12.5, page 83), i.e. your washing machine's washing cycle must be completed by 6:00 p.m.

The longest washing cycle of your washing machine lasts three hours. Therefore, enter at least three hours as the maximum program runtime when configuring the switching device. In this case, the washing machine will start at 3:00 p.m. at the latest so that the longest washing cycle can be completed. If the selected washing cycle is of shorter duration, the Sunny Home Manager still adheres to the maximum program runtime.



**Procedure:**

- Enter the maximum program operating time for the load connected in the **Max. program operating time** text field (see the load manual).

**12.4.6 Entering the Minimum Switch-On and Switch-Off Time**

- This option can only be set for **non-program-controlled** loads.

**i Information about configuring switch-on and switch-off times**

Loads are not designed to be switched on and off an infinite number of times during their service life. Internal components such as relays can fail after several thousand switching cycles due to material fatigue. In fickle weather conditions with highly variable PV power generation, the load may be switched on and off every few minutes because there is only enough surplus PV energy for brief periods.

You can set minimum switch-on and switch-off times when configuring the load characteristics in order to prevent loads from being switched on and off too frequently and experiencing too many switching cycles. If this is done, however, power may be drawn from the utility grid to operate the load if PV power generation drops briefly.

Conversely, surplus PV energy may be "lost" during switch-off times.

If you select a long minimum switch-on time, by contrast, the load may not be switched on very often since there are very few adequately long periods in the PV power generation forecast with enough power to operate the load during the overall minimum switch-on time.

It is worth trying out different time settings in order to gradually find the best values for each load.

Setting	Explanation
Minimum switch-on time	<p>The minimum switch-on time is the minimum time that the load connected must remain switched on, for example, to complete its starting sequence or complete a work sequence.</p> <p><b>Delayed activation possible:</b></p> <p>Some loads may not start to operate immediately after switching on the assigned switching device, e.g. heat pumps for water storage tanks. Immediate activation can only be ensured for the switching device, not for the connected loads.</p> <ul style="list-style-type: none"> <li>• Enter the minimum switch-on time in the <b>Minimum switch-on time</b> text field. Take into consideration any possible delays in starting the connected load.</li> </ul>
Minimum switch-off time	<p>The minimum switch-off time is the minimum time the connected load must remain switched off, for example, to prevent overheating or enable restarting.</p> <ul style="list-style-type: none"> <li>• Enter the minimum switch-off time in the <b>Minimum switch-off time</b> text field.</li> </ul>

**12.4.7 Setting the Priority of the Load**

Here you can set which priority Sunny Home Manager should plan for the load. This setting is coupled with the configuration of the time period.

**Requirements:**

- The load must be connected to a switching device.
- For the load, a time period of the type **Load CAN be switched on** must be set.

**Procedure:**

- Set the slider to the desired level.

**12.4.8 Assigning a Switching Device**

If a load is connected to the Sunny Home Manager via a switching device, you must assign the switching device to the load:

- So that the Sunny Home Manager can measure the energy consumption of the load

- So that the Sunny Home Manager can read out the data of the load and control the load
- So that the Sunny Home Manager save the data of the load

If a load was temporarily not assigned to any switching device, corresponding data gaps will appear in the diagrams such as **Current status and forecast**.

A load can be connected to another (free) switching device at any time and controlled via this; the measured values or consumption data basically remain with the load and can only be called up via the load itself.

**Procedure:**

- In the drop-down list **Device assignment**, assign a device to the load for measuring and/or switching. By default, no switching device is assigned to the load.  
If the desired switching device is already assigned to a different load, a "\*" will be displayed in front of the name of the switching device. In order to be able to reassign the switching device, you must first remove the assignment of the switching device in the profile of the other load.

### 12.4.9 Setting Measuring and Switching of the Assigned Device

As soon as you have assigned a switching device to a load, you must specify whether this switching device is to only switch the load on and off or whether the energy demand of the load is to be measured as well.

These two options are explained in the table below:

Setting	Explanation
The assigned device is to measure and switch (intelligent power consumption)	The load draws electric current via the switching device. Using the consumption values measured by the switching device, the Sunny Home Manager "learns" how much power the load typically consumes. Sunny Home Manager uses this information for load planning and load control.
The assigned device is only to switch, not measure (fixed power consumption)	The load is switched e.g. via a relay which is connected to the radio-controlled socket. Using the connected relay, the radio-controlled socket switches the load only in accordance with the configuration (time period) and the specifications of the Sunny Home Manager.  The value that is entered in the field <b>Power Consumption</b> is the power consumption factored in for planning the load.

**Procedure:**

- In the drop-down list **Measuring and switching**, select the required setting.

### 12.4.10 Setting Automatic Switch-Off

- The load must be **non-program-controlled**.

Devices such as heating elements or fan heaters have their own automatic switch-off. An integrated thermocouple ensures that the device automatically switches off upon reaching a configurable temperature threshold. The Sunny Home Manager registers this disconnection via the switching device connected to the load and also switches off the switching device for safety reasons. However, the switching device must first be able to detect whether the load is in operation or in standby mode. You have to enter this detection value. With these settings, you also avoid a premature disconnection of the load, so that it can also run for longer than the configured time period if necessary.



### Heating element with automatic switch-off

When controlled via a switching device, the heating element is switched on and off depending on the availability of PV energy within the time period defined. If the automatic switch-off is activated and the water has not yet reached the set temperature at the end of the time period, the heating element can continue to draw electric current from the switching device even though the time period has expired, until the target temperature is reached and the heating element has switched to standby mode on its own. The Sunny Home Manager recognizes the standby mode of the heating element and switches the switching device off.

#### Procedure:

1. In the field **Load has internal automatic switch-off**, activate the checkbox **Yes**.
2. If required, in the text field **Threshold for disconnection**, enter the lower threshold for the power consumption of the load in standby mode (typically 50% of the mean power consumption in operation). When the power consumption falls below this threshold, the Sunny Home Manager recognizes the switch to standby mode and disconnects the switching device.
3. If required, in the text field **Detection time for disconnection**, enter the minimum time period over which the power consumption must be below the lower threshold for disconnection in order that the Sunny Home Manager recognizes the switch to standby mode.

## 12.5 Configuring the Time Period

You can define one or more time periods for a load in which the Sunny Home Manager can or must switch on this load.



### Length of time period

The time period in which the load should be operated must be much longer than the actual operating time so that Sunny Home Manager has enough flexibility within the time period to identify the time when energy is the cheapest.



### Shorter service life of switching devices through frequent switching of loads

When setting time periods and device operating times, make sure that the load does not have to switch loads on and off unnecessarily often.

Discard
Configure time period (Quantity: 1)
Accept

---

### Time period overview

Mon  
Tue  
Wed  
Thu  
Fri  
Sat  
Sun

0 6 12 18 24

**Name of Load:** Washing machine + Add time period

(1) **Load running:**  
 daily  Only on the following weekdays

**Available time period for the operation of the load** (Length of time period: 14h)  
 06 : 00 - 20 : 00

Load must be switched on  Load can be switched on

**Load will be switched on depending on:**  
 Proportion of the PV energy  Maximum permitted energy costs

Purchased electricity: 35 %  
 PV power generation: 65 %  
 Surplus PV energy: 0 %

-- Limiting of the active power feed-in

Figure 15: Configuring the time period (example)

## Setting or changing the time windows

1. Select **Configuration > Load Overview and Planning** in the page and menu selection.
2. In the line of the desired load, in the column **Configuration**, select the symbol .
3. In the tab of the selected load, select the button **[Edit]**.
4. Select **[Configure time period]**.
  - On the left, the time period overview shows the current (possibly preset) information; on the right, the field for setting or changing the time period for the selected load.
5. Under **Load is switched on** you must select whether the load should run **Daily** or **Only on the following weekdays**.  
 If the load should only be operated on certain days of the week, you must click on the corresponding day(s) of the week in the line that opens.
6. Under **Available time period for the operation of the load**, enter the desired start time and end time.
7. Under **Maximum operating time of the load in the time period**, use the slider to set the operating time in 5-minute intervals.
8. Select the time period type **Load MUST be switched on** or **Load CAN be switched on**.
9. If you have selected the time period type **Load MUST be switched on**, you can set a checkmark to allow the load to exceed the time period. If you do not set this checkmark, the load must not exceed the specified time period.

10. If you have selected the time period type **Load CAN be switched on**, you must use **Load is switched on depending on** to define the conditions under which the load should be switched on.
  - If you select **Proportion of the PV energy**, you must use light bulb slider to set the minimum proportion of PV energy that must be present so that Sunny Home Manager will switch on the load during the configured time period.

For example, if you set the slider to 50%, the device (e.g., a heating element) will be turned on only when there is enough PV energy to meet 50% of the energy demand.  
The percentages for each energy type are displayed to the right of the slider.
  - If you select **Maximum permitted energy costs**, you must use the light bulb slider to set the maximum energy costs at which Sunny Home Manager will switch on the load during the configured time period.



For example, if you set the slider to 0 Euro/kWh, the device will be switched on only when there is enough surplus PV energy or when there is more PV energy available than can be fed into the utility grid.  
The costs are displayed in Eur/kWh to the right of the slider.
11. Select **[Accept]**.
12. Click on **[Save]**.

The time periods configured according to weekdays are shown as colored bars in the **Load planning** area.

### Adding an Additional Time Period

If a load is not to run throughout the day, but rather at predefined intervals (e.g. pond pump), you must set up several consecutive time periods for this day. Here, the number of time periods equates to the number of intervals in which the load is to run.



#### Procedure:

1. Select **Configuration > Load Overview and Planning** in the page and menu selection.
2. In the line of the desired load, in the column **Configuration**, select the symbol .
3. In the tab **Name of Load**, select the button **[Edit]**.
4. Select **[Configure time period]**.
5. Select **Add time period** .
- A new time period with the corresponding number will be displayed in the **Time period overview**.
6. Make the desired settings.
7. Select **[Accept]**.
8. Click on **[Save]**.

### Deleting a Time Period

You cannot delete all the time periods for a load. At least 1 time period must always be configured for each load. If no switching device is assigned to the load, however, the time period has no effect on the operation of the load.

#### Procedure:

1. Select **Configuration > Load Overview and Planning** in the page and menu selection.
2. In the line of the desired load, in the column **Configuration**, select the symbol .
3. In the tab **Name of Load**, select the button **[Edit]**.
4. Select **[Configure time period]**.
5. Select the recycle bin  for the desired time period and confirm the security prompt.
6. Select **[Accept]**.
7. Click on **[Save]**.

## 12.6 Directly Controlling Loads

### Requirements:

- You must have the user role **Installer** or **PV System Administrator** (see Section 16.1, page 113).
- The load must either support the data exchange protocol EEBUS or the data exchange protocol SEMP (see the manual of the load and technical information at [www.SMA-Solar.com](http://www.SMA-Solar.com)).

### Procedure:

1. Connect the load to the local network and carry out the manufacturer-specific registration (see manual of the load). The load must be located in the same local network as the Sunny Home Manager.
2. EEBus devices must each be actively paired with the Sunny Home Manager (see Section 11.6.1, page 65). This step is omitted for SEMP devices; they are identified automatically.
  - The Sunny Home Manager detects the new load in the local network.
  - The load is displayed on the page **Device Overview > Overview of New Devices**.
3. Add the load to the Sunny Home Manager system. In the case of loads with optional energy consumption, you can also set the priority and the maximum permissible energy costs.
  - The new load is automatically displayed on the page **Load Overview and Planning** with the available information and setting options.
4. Change the load name if necessary.

## 13 Visualization of the energy management

### 13.1 System selection with system list

**i** If only 1 system is assigned to your e-mail address, this menu is not shown to you.

All systems that are assigned to your e-mail address are listed under the menu item **PV system selection**. In the **PV system list** you can choose between the options **Simple list** and **Extended list** and sort the list.

System List	Explanation / Display per System
Simple list	<ul style="list-style-type: none"> <li>• Power of the system (kWp)</li> <li>• Date of commissioning</li> <li>• Location of the system (country, zip code, city)</li> </ul>
Extended list	<ul style="list-style-type: none"> <li>• Nominal system power (kW)</li> <li>• Total yield (kWh) for the following time periods:               <ul style="list-style-type: none"> <li>- previous day</li> <li>- Current day</li> <li>- Previous month</li> <li>- current month</li> </ul> </li> <li>• Total yield (kWh) as per meter reading</li> <li>• Specific yield (kWh/kWp) for the following time periods:               <ul style="list-style-type: none"> <li>- current month</li> <li>- current year</li> </ul> </li> </ul>

#### Sorting the System List

- When first calling up the page, the simple list is shown.
- The extended system list is sorted in ascending order in accordance with the specific system yield.

#### Sort the simple list:

1. To sort the simple list, click in the header of the table on the blue title of the column according to which the list is to be created. The list is then displayed in ascending or descending order according to this criterion.
2. To permanently keep this view, click on the field **Show this list after login** and select **[Save]**.

#### Sort the extended list:

1. To sort the list by another value than the specific system yield, click one of the other blue values in the header.
2. To sort the list in descending order, click on the blue value in the header again.

## 13.2 System overview

The menu page **PV system overview** shows all available data of your system.

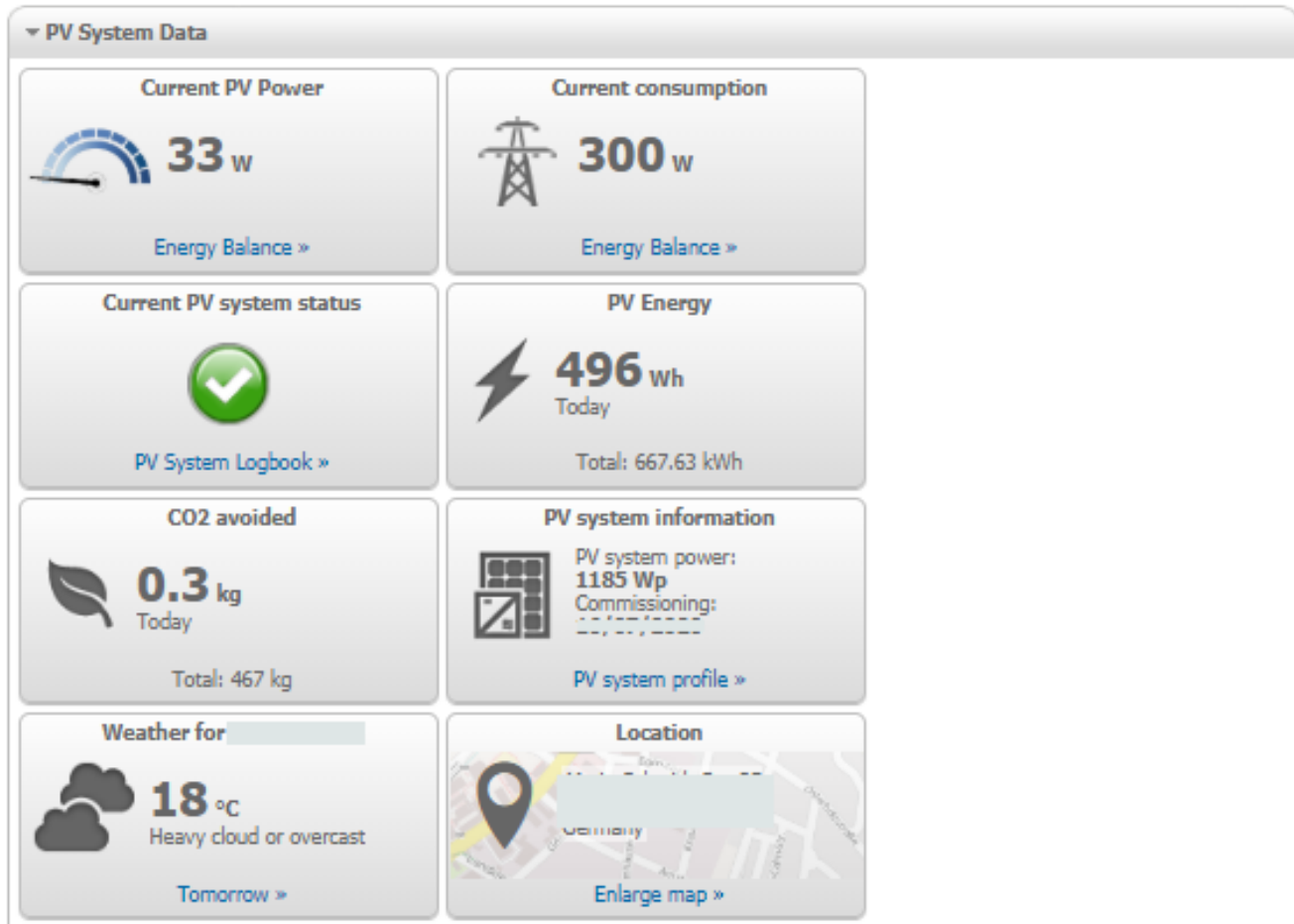

Figure 16: Example of a system

## 13.3 Current Status And Forecast

The Sunny Home Manager continuously logs the energy generated by the PV system. The Sunny Home Manager receives the PV generation data via the connected SMA inverters or via an optionally connected PV generation meter (e.g. an SMA Energy Meter). The Sunny Home Manager also receives location-based weather forecasts via the Internet. Based on this information, the Sunny Home Manager forecasts how much energy your PV system will likely generate in the next 48 hours and thus will be available.

The Sunny Home Manager includes the forecast of the energy availability in its energy planning and suggests cost-effective operating times for home appliances, for example.

To query forecast information, in the **Configuration** menu on the **System properties** page under **PV system data**, the following input fields must be completed:

- Longitude
- Latitude
- Nominal PV system power (necessary for the correct power forecast)

If one of the three entries is missing in the forecast area, either the weather symbols are not displayed, the power forecast is not present or it is incorrect.

### 13.3.1 Overview Current Status Area

The graphic in the area Current Status visualizes the power transferred from your PV system to your household from the utility grid to your household and from your PV system to the utility grid.



**Requirements for displaying this page:**

- The data request interval must be set to **Automatic** (see Section 11.3.8, page 58).

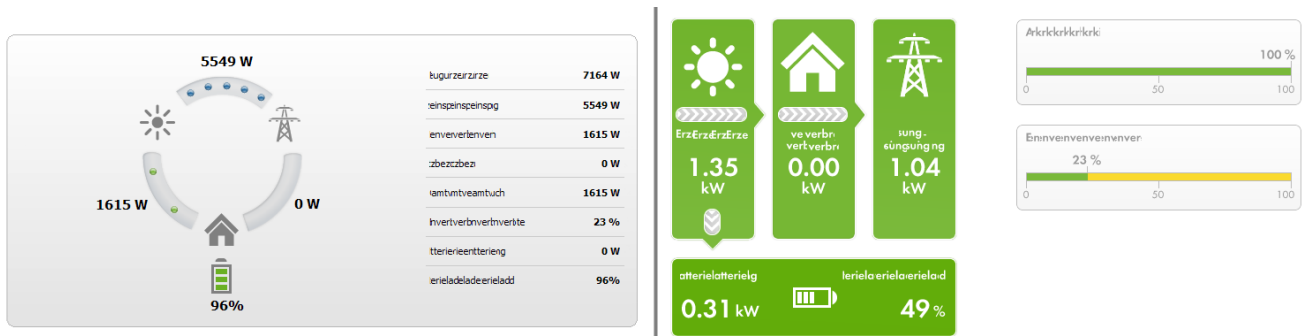

Figure 17: Display: left **Option I** and right **Option II** (examples)

The displays **Option I** and **Option II** contain the following current data:

Designation	Explanation
PV Generation	Currently generated power of your PV system
Consumption (total consumption)	Power that your household is currently drawing from your PV system, the utility grid and the battery for <b>Option II</b> : The colors visualize which portion of the consumption is currently made up of purchased electricity, direct consumption (PV system) and battery discharging.
Grid supply	Power that your household is currently drawing from the utility grid. for <b>Option I</b> : red
Grid feed-in	Power that your PV system is currently feeding in to the utility grid. If your system is generating more power than your household needs at the moment or can be stored in the battery, the surplus power is fed into the utility grid. for <b>Option I</b> : blue
Self-consumption	Power that your household is currently drawing from your PV system (direct consumption) and, if applicable, power/energy being stored into the battery from your PV system. for <b>Option I</b> : green
Self-consumption quota	Current ratio of self-consumption to PV power.
Self-sufficiency quota	Current ratio of internal power supply to total consumption
<b>Only option II</b>	Internal power supply: Power that your household is drawing directly from your PV system (direct consumption) and, if applicable, from the battery (battery discharging). In systems without batteries, the self-consumption is the same as the internal power supply.
Only displayed for systems with battery:	
Battery charging	Power that is being currently charged from your PV system into the battery
Battery discharging	Power that your household is currently drawing from the battery
Battery state of charge	Current state of charge of the battery in percent, in relation to the battery capacity

- i** Only for systems with self-consumption can be chosen between **Option I** and **Option II**.  
For systems without self-consumption only Option I is possible and the configuration block is hidden.

### Changing the display:

1. Select [**Configuration - Current status and forecast**] in the contents area on the page **Current status and forecast**.
2. Select the desired option in the field **Display**.
3. Confirm the selection with [**Save**].

## 13.3.2 Overview Forecast and Recommended Action Area

The graphic in the area Forecast and Recommended Action gives an overview of the expected PV power as well as recommendations on the manual switching-on of loads.

In addition the graphic shows the time periods that you have planned for the operation of the loads (see Section 12.5, page 83).

You can have a forecast displayed for up to 48 hours from the currently selected time.

- i** You can select another period by clicking on the diagram, holding down the left mouse button and moving the mouse to the right or left.

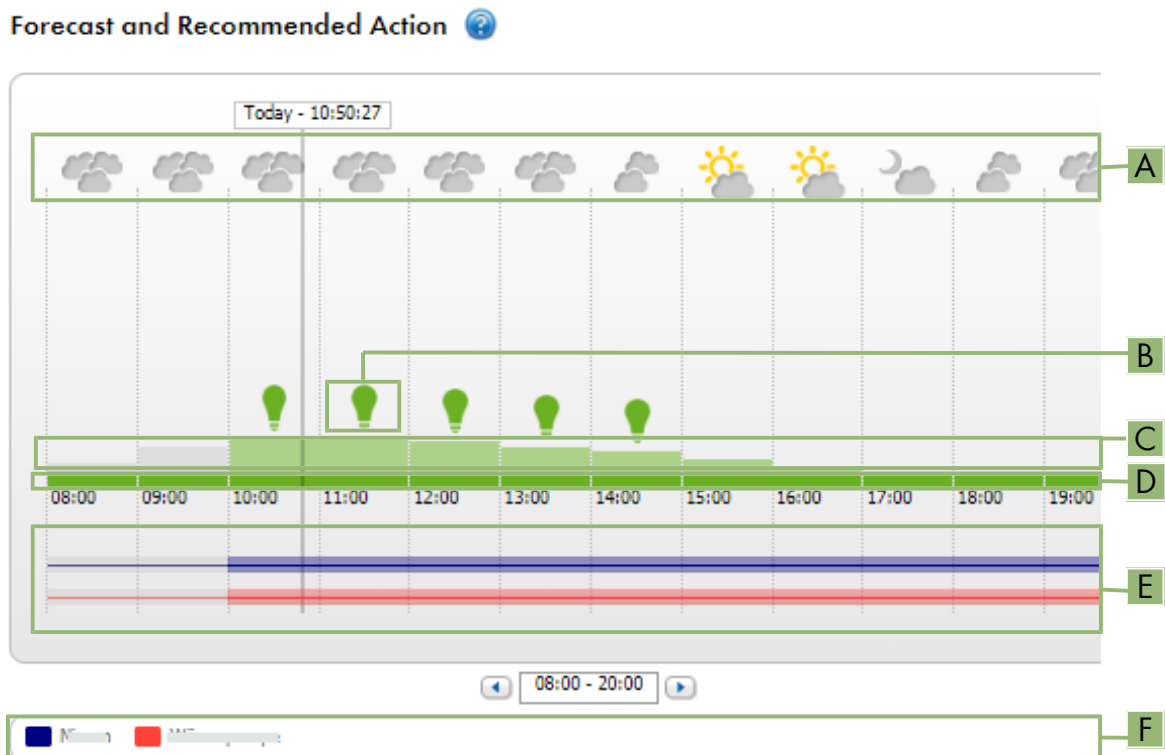

Figure 18: **Forecast and Recommended Action** diagram (example)

Position	Explanation
A	Weather forecast

Position	Explanation
B	<p>Suitable time for manually switching on loads</p> <p>The Sunny Home Manager takes the following information into consideration for the recommended action:</p> <ul style="list-style-type: none"> <li>• Expected PV power (see position C) Requirement: The location of the system must be set.</li> <li>• Expected energy consumption of the household and of loads for which the Sunny Home Manager receives measured values of the power consumed via switching device or via direct communication. The Sunny Home Manager determines the anticipated energy consumption in accordance with the consumption forecast based on the "learned" consumption behavior of the individual household. Requirement: The data collection of the loads must be activated.</li> <li>• Feed-in tariff and electricity tariff Requirement: The feed-in tariff and electricity tariff must be entered.</li> <li>• Optimization target The optimization target indicates whether the Sunny Home Manager should prioritize ecological- or economical factors during load management.</li> <li>• Azimuth and tilt angle Requirement: The inverter strings must be configured.</li> </ul>
C	<p>Expected PV power in accordance with the PV yield forecast</p> <p>The Sunny Home Manager determines the available PV power that can be expected in each case using the weather forecast for the selected location and the "learned" behavior of the specific system.</p> <p>Tip: When you move the mouse over one of the bars, the following details for this time period will be displayed in a window:</p> <ul style="list-style-type: none"> <li>• Estimated PV generation</li> <li>• Estimated consumption</li> <li>• Difference between the estimated PV generation and estimated consumption</li> </ul>
D	<p>Tariff for the electric current purchased from the utility grid</p> <ul style="list-style-type: none"> <li>• Red: expensive</li> <li>• Green: good value</li> </ul> <p>If you have only entered 1 electricity tariff, green is always displayed.</p> <ul style="list-style-type: none"> <li>• Other colors: electricity tariffs between the highest and the lowest electricity tariff</li> </ul>
E	<p>View of the time periods for the planned operation of the loads (load prognosis)</p> <ul style="list-style-type: none"> <li>• The configured time periods are shown as colored, semi-transparent bars.</li> <li>• Time periods planned by the Sunny Home Manager in which the loads were actually in operation or are going to be in operation are shown as colored, solid bars.</li> </ul> <p>A simple solid line symbolizes times during which the self-consumption of the load is measured.</p>
F	<p>Loads legend</p> <p>The legend shows which color is assigned to which load in the time period view (E).</p>

## 13.4 Energy Balance

This page visualizes the progression of the energy generation and energy consumption for a selected period. provides analyses for generation, consumption, self-consumption and battery usage.

A two-part diagram displays how the loads in your system have been supplied and how your PV energy has been used:

- The upper half of the diagram shows the total consumption of your system in the selected period. It is precisely broken down from which sources your system was supplied with energy (PV system, battery-storage system or utility grid).
- The lower half of the diagram shows when and how much electrical PV energy has been generated and how it was used (direct consumption, charging of a battery-storage system or utility grid feed-in).

**i** The data on this page are only fully displayed if both a feed-in meter and grid-supply meter are connected. The additionally required PV generation data will be determined either directly by the connected SMA inverters or can be captured via an additional PV production meter in PV systems with Sunny Home Manager. If a DC-coupled storage system is used (e.g. Sunny Boy Smart Energy), the PV production data must always be read out directly from the device, otherwise no differentiation between direct consumption and battery charging or discharging is possible.

Via **Tabs** you can select the period which is to be displayed in the view (current / day / month / year / total).

## Energy Balance

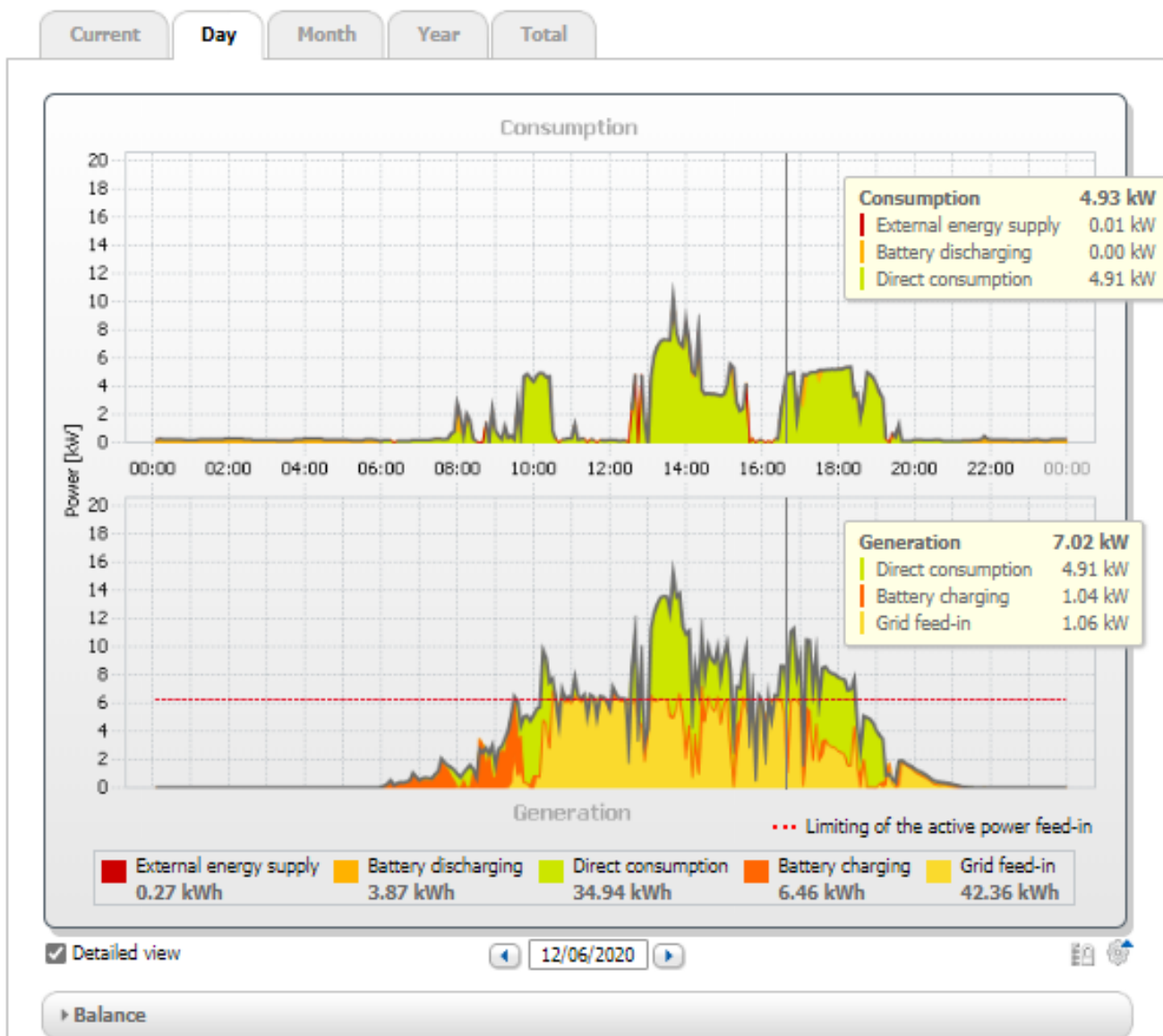

Figure 19: Energy balance of a specific day (example)

### **i** Reading out the data

- When you move the mouse pointer over the diagram, a vertical line is displayed. You can use this line to move to a specific point in time on the time axis. The power or energy values of the diagram for this desired point in time are displayed.
- When you move the mouse over one of the displayed terms in the legend, an explanation of this term is displayed.
- If you want to display only selected data, click with the mouse on one or more terms in the legend to hide or show them again.

### Energy consumption and energy generation

Designation	Explanation
Consumption	Power that your household drew from your system (direct consumption or internal power supply for systems without battery), the utility grid (grid-supplied power) and, if applicable, the battery (battery discharging) during the period selected.
Grid supply	Energy that was drawn from the utility grid during the period selected.
Internal power supply	Energy used in the system that did not come from the utility grid, but rather was generated on site. It is made up of directly used PV energy (direct consumption) and stored PV energy (battery discharging). The internal power supply quota describes which proportion of the energy used in the system comes from that generated on site.
Yield	Energy that was supplied to your household by your PV system during the period selected. For systems with battery, the energy comes preferably directly from the system (direct consumption). If the power produced by the system is not sufficient, the remaining power is supplied by discharging the battery.
Self-consumption	PV energy that is used on-site and not fed into the utility grid. It is made up of directly used PV energy (direct consumption) and stored PV energy (battery charging). The self-consumption quota describes which proportion of the PV energy generated on-site has been used on-site.
Grid feed-in	Energy that your PV system fed into the utility grid during the period selected.
Self-sufficiency quota	Ratio of energy self-sufficiency to consumption in the period selected
Only displayed for systems with battery:	
Direct consumption	Power that your household drew and consumed directly from your PV system during the period selected, without intermediate storage in the battery.
Direct consumption quota	Current ratio of direct consumption to PV power
Battery charging	Energy that your PV system stored in the battery during the period selected.
Battery discharging	Energy that your household drew from the battery during the period selected.

On the tabs **Current** and **Day** the gray envelope curve visualizes the consumption (grid-supplied power and energy self-sufficiency) and the generation (direct consumption and grid feed-in) for the selected period or the selected day.

On the tabs **Month**, **Year** and **Total** the gray envelope curve visualizes the generation (direct consumption and grid feed-in) for the selected period. The envelope curve is only visible if the data are incomplete or cannot be calculated, or if the components of the generation are hidden using the legend below the diagram.

### Limitation of Active Power Feed-In

The dotted red line indicates the maximum active power that may be fed into the utility grid.

- The dotted red line will only be displayed if you have set a limit for active power feed-in for your PV system in the Sunny Home Manager.
- The line is only displayed in the diagrams of the tabs **Current** and **Day**.
- If you have limited the active power feed-in to 0%, the red line runs directly on the x-axis of the diagram. Limitation of the active power feed-in to 0% is only supported by inverters that support the fallback function (fallback: in the event of a communication failure between the Sunny Home Manager and the inverter, the inverter reverts to an output power of 0 watts). For more information see the inverter manual at [www.SMA-Solar.com](http://www.SMA-Solar.com).

The **Legend** below the diagram explains the colors used in the diagram and displays the most important overall values for the time period displayed.

Under **Balance**, the calculated values for the self-sufficiency and self-consumption quota, which reflect the type of your own energy supply, as well as other total values for the period shown are displayed.

### Display with Battery

If a battery inverter is present in your system, you can select between the simplified view without battery data and the detailed view with battery data. To have the battery data in the diagram and in the **Balance** area displayed, you must activate or deactivate the checkbox **Detailed view**.

## 13.5 Load Balance and Control

### 13.5.1 Overview load balance and control

#### Requirements for displaying the page:

- In the Sunny Home Manager system, loads must be available and configured which are either indirectly controlled by a switching device or which can be directly controlled by the Sunny Home Manager.



The diagrams and tables on this page provide an overview of the operating time, operating duration and energy consumption of the **loads** controlled by the Sunny Home Manager as well as the energy mix used (from own PV generation and grid-supplied power).

For better assessment, the **type of load** is indicated for all loads (see Section 12.4.2, page 79). If **No assignment** is entered for a load in the column Type of load, this means that no load has yet been assigned to this switching device (see Section 12.3.3, page 75).

In the **Configuration** column, the gearwheel icon  takes you directly to the **Load properties** tab (in the menu Configuration > Load overview and planning page), on which you can configure different details depending on the load type, such as the priority of the load (see Section 12.4, page 77).

Depending on the tab, the diagram and table show different views and data of the loads:

Tab	Content
Currently	<p><b>The following is required to display the tab Current:</b></p> <ul style="list-style-type: none"> <li><input type="checkbox"/> The data request interval must be set to <b>Automatic</b> (see Section 11.3.8, page 58).</li> </ul> <p>Use energy meters recommended by SMA. Otherwise there may be a delay in the data being displayed in the Current tab.</p> <p>The tab shows the following current data:</p> <p>In the diagram:</p> <ul style="list-style-type: none"> <li>• Line at the bottom of the diagram: Live data on the flow of the consumed power of each load in the selected display period (slider).</li> </ul> <p>In the table:</p> <ul style="list-style-type: none"> <li>• <b>Load and type of load</b></li> <li>• <b>Operating Mode:</b> Operating mode of the assigned device The button of the currently selected operating mode is highlighted in color. In addition, the LED status is displayed via an LED symbol and the current status is explicitly stated. The operating mode can be changed using the buttons. If the operating mode is controlled via the Sunny Home Manager, <b>(Automatic)</b> appears behind the operating mode. If the Sunny Home Manager has switched on a load connected via a radio-controlled socket, its start-up detection is locked for the duration of the program runtime (see Section 12.3.6, page 76) and the following information is displayed: <b>Automatic start-up detection is locked.</b></li> <li>• <b>Current value of consumption:</b> Power currently being drawn by the load</li> <li>• <b>Configuration</b></li> </ul>

Tab	Content
Day	<p>In the diagram:</p> <ul style="list-style-type: none"> <li>• With selected view <b>Stacking order view</b> ( <li>- To hide a load, click on the desired load. Loads that have been hidden will be displayed in gray in the legend. You can display the load again by re-clicking on the load.</li> <li>- To show all loads that have been hidden, select <b>Show all</b> below the legend.</li> <li>- To display only the values for battery charging, overall consumption and purchased electricity in the diagram, select <b>Display standard</b> below the legend.</li> <li>- To change the stacking order in the diagram, select the desired load and, holding down the left mouse button, drag it to the desired position in the legend.</li> </li></ul> <li>• With selected view <b>Time period</b> ( <li>- A thin line indicates that (in this time range) no time window is set.</li> <li>- Bright bars indicate time windows that have either been configured for the operation of the load or that have been registered with the Sunny Home Manager for directly communicating loads to cover their energy demand. The energy demand is therefore registered in both cases, but the Sunny Home Manager has not switched on the load (e.g. due to the weather forecast).</li> <li>- Dark-colored bars show the time periods for which the loads were actually in operation. Additional play and stop icons indicate the exact time at which the Sunny Home Manager has switched the load on or off.</li> <p>If you move the mouse pointer over one of the dark-colored bars, the energy consumed by the load in this time period is displayed in kWh.</p> </li> <p>In the table:</p> <ul style="list-style-type: none"> <li>• <b>Load and type of load</b></li> <li>• <b>Daily consumption:</b> Energy drawn by the load on the selected day</li> <li>• <b>Configuration</b></li> </ul>



Tab	Content
Month	<p>In the diagram:</p> <ul style="list-style-type: none"> <li>Energy drawn by each load in the selected month in days</li> </ul> <p>If you move the mouse pointer over one of the bars in the diagram, a window opens with the following information:</p> <ul style="list-style-type: none"> <li>The respective daily consumption of the loads operated on that day</li> <li>The respective percentage of the daily consumption which was covered by PV energy (☀️), battery discharging (🔋) or by the utility grid (🏠)</li> </ul> <p>In the table:</p> <ul style="list-style-type: none"> <li><b>Load and type of load</b></li> <li><b>Monthly consumption:</b> Energy drawn by the load in the selected month</li> <li><b>PV energy percentage:</b> Percentage of the monthly consumption covered by PV energy</li> <li>Only for systems with battery: <b>Battery discharging percentage:</b> Percentage of the monthly consumption covered by battery discharging</li> <li><b>Purchased electricity percentage:</b> Percentage of the monthly consumption covered by the utility grid</li> <li><b>Configuration</b></li> </ul>
Year	<p>In the diagram:</p> <ul style="list-style-type: none"> <li>Energy drawn by each load in the selected year in months</li> </ul> <p>In the table:</p> <ul style="list-style-type: none"> <li><b>Load and type of load</b></li> <li><b>Annual consumption:</b> Energy drawn by the load in the selected year</li> <li>Only for systems with battery: <b>Battery discharging percentage:</b> Percentage of the annual consumption covered by battery discharging</li> <li><b>PV energy percentage:</b> Percentage of the annual consumption covered by PV energy</li> <li><b>Purchased electricity percentage:</b> Percentage of the monthly consumption covered by the utility grid</li> <li><b>Configuration</b></li> </ul>
Total	<p>In the diagram:</p> <ul style="list-style-type: none"> <li>Energy drawn by each load in the individual years</li> </ul> <p>In the table:</p> <ul style="list-style-type: none"> <li><b>Load and type of load</b></li> <li><b>Total consumption:</b> Total energy drawn by the load so far</li> <li><b>PV energy percentage:</b> Percentage of the total consumption drawn from PV energy</li> <li>Only for systems with battery: <b>Battery discharging percentage:</b> Percentage of the total consumption drawn from battery discharging</li> <li><b>Purchased electricity percentage:</b> Percentage of the total consumption drawn from the utility grid</li> <li><b>Configuration</b></li> </ul>
Open-loop control	<p>This tab represents the table of the tab "Current", i.e. identical data are shown; the graphic is missing here compared to the tab "Current".</p>

## 13.5.2 Selecting the Load Display

### Showing and hiding loads

Using the **Legend** below the diagram, you can show and hide the loads displayed in the diagram.

#### Procedure:

1. To hide a load, click on the desired load.
  - Loads that have been hidden will be displayed in gray in the legend.
2. You can display the load again by re-clicking on the load.
3. To show all loads that have been hidden, select **Show all** below the legend.

### Selecting the load color

The loads are displayed in different colors in the diagrams for better visualization. The assigned color can be changed if necessary.

#### Procedure:

- Click on the color square next to the desired load in the list below the diagram and choose a new color from the color palette.

## 13.6 Display of the nominal system power

### 13.6.1 System yield in the annual comparison

The system yields of previous years are compared to each other in a diagram with associated table on the menu page **Annual comparison**. Thus, the system must have been in operation for more than 1 year so that data for an annual comparison can be displayed here.

The expected average yield results from a manual specification that you can make based on your system's location data. Depending on the orientation and the irradiation fluctuations between the individual years, there might be considerably larger deviations in contrast to the expected average yield.

Tab	Content
Total yield	<p>In the diagram:</p> <ul style="list-style-type: none"> <li>• Yield development over the previous years</li> <li>• Average yield development over the previous years</li> <li>• Average expected yield</li> </ul> <p>In the table:</p> <ul style="list-style-type: none"> <li>• Yield values (kWh/kWp) of the previous years and the current year per month as well as added up.</li> <li>• Mean values per month</li> <li>• Proportion year (can only be displayed once a full year has passed)</li> <li>• Expected yield</li> </ul>
Specific system yield	<p>In the diagram:</p> <p>The specific system yield is a key figure for describing the quality of a system. System-specific factors such as location, tilt angle, shading, module and inverter types are taken into consideration to calculate the specific system yield. The specific system yield enables you to compare various systems at various locations.</p> <ul style="list-style-type: none"> <li>• Development of the specific system yield of each previous year</li> <li>• Average development of the specific system yield of the previous years</li> <li>• Average expected yield</li> </ul> <p>In the table:</p> <ul style="list-style-type: none"> <li>• Specific system yield (kWh/kWp) of the previous years and the current year per month as well as added up.</li> <li>• Mean values per month</li> <li>• Proportion year (can only be displayed once a full year has passed)</li> <li>• Expected yield</li> </ul>

### Calculation of the expected yield

The button **Edit prediction values** takes you directly to the menu where you enter the specific annual yield and can have the expected annual yield calculated (see Section 10.4.9, page 48).

The **Predicted annual yield** of the PV system is calculated from the specific annual yield (kWh/kWp) at the PV system location and the PV system power (kWp).

You can obtain the specific annual yield for your PV system location from irradiation maps. Local conditions such as shading or the system orientation are not taken into account. You can obtain the nominal system power from your installer.

The **Monthly distribution of the expected annual yield** shows how the expected annual yield is distributed throughout the year. Given complete information about the system location, Sunny Portal can suggest a distribution. For this, click on the button [**Suggest a monthly distribution**].

You may also enter a percentage value for each month (the sum must result in 100%).

You can enter or change all data regarding your system in the **Configuration** menu on the **PV system properties** page.

## 13.6.2 Nominal system power analysis

### 13.6.2.1 Overview analysis

On the page **Analysis**, you can compare the power and yield values of individual inverters with one another or with the complete system.



Figure 20: **Analysis** menu page (example)

Position	Explanation
A	<b>Device Selection</b> area
B	Tabs
C	Diagram preview (Not shown on the <b>Total</b> tab)  The diagram preview is divided into sections by lines. If you select a section in the diagram preview, the content is shown in the large diagram.
D	Large diagram  Tip: If you move the mouse on to the diagram, the value from the area <b>Details</b> is shown next to the cursor.
E	<b>Total yield</b> or <b>Spec. total yield</b>  Depending on the type of display selected in the area <b>Device selection</b> , the total yield or specific total yield will be displayed here.

Position	Explanation
F	<p><b>Details</b> area</p> <p>This area contains the power values of the displayed diagram as 15-minute mean values.</p>
G	<p><b>Logbook</b> area</p> <p>This area contains messages from selected devices and associated higher-level system messages.</p>

### Display on the tabs

Tab	Explanation
Day	<p>Diagram preview:</p> <ul style="list-style-type: none"> <li>Preview of diagrams with the progression of the PV system yields for individual days Tip: If you move the cursor over a day in the diagram, the total yield of the PV system for this day is shown.</li> </ul> <p>Large diagram:</p> <ul style="list-style-type: none"> <li>Power value curve as 15-minute mean values of the selected devices for the selected day</li> <li>Bottom right in the diagram<sup>2)</sup>: Total yield of the PV system for the selected day</li> </ul>
Week	<p>Diagram preview:</p> <ul style="list-style-type: none"> <li>Preview of diagrams with the progression of the PV system yields for individual weeks Tip: If you move the cursor over a week in the diagram, the total yield of the PV system for this week is shown.</li> </ul> <p>Large diagram:</p> <ul style="list-style-type: none"> <li>Power value curve as 15-minute mean values of selected devices for the selected week.</li> <li>Bottom right in the diagram<sup>2)</sup>: Total yield of the PV system for the selected week</li> </ul>
Month	<p>Diagram preview:</p> <ul style="list-style-type: none"> <li>Preview of diagrams with the yield values of the PV system for each month in days Tip: If you move the cursor over a month in the diagram, the total yield of the PV system for this month is shown.</li> </ul> <p>Large diagram:</p> <ul style="list-style-type: none"> <li>Yield values of selected devices for the selected month in days</li> <li>Bottom right in the diagram<sup>2)</sup>: Total yield of the PV system for the selected month</li> </ul>
Year	<p>Diagram preview:</p> <ul style="list-style-type: none"> <li>Preview of diagrams with the yield values of the PV system for each year in months Tip: If you move the cursor over a year on a diagram, the total yield of the PV system for this year is shown.</li> </ul> <p>Large diagram:</p> <ul style="list-style-type: none"> <li>Yield values of the selected devices for the selected year in months</li> <li>Bottom right in the diagram: Total yield of the PV system for the selected year</li> </ul>
Total	<p>Large diagram:</p> <ul style="list-style-type: none"> <li>Yield values of selected devices for individual years</li> <li>Bottom right in the diagram<sup>2)</sup>: Total yield of the PV system for all years together</li> </ul>

<sup>2)</sup> Only displayed if the checkbox **Complete PV system** is activated in **Device selection**

### 13.6.2.2 Setting the Device Selection

In the **Device selection** area, you can select whether the complete system and/or individual inverters are to be displayed in the large diagram and in the **Details** area. Moreover, you can select whether absolute or specific values are to be displayed.

#### Selecting devices:

1. To display the values of the complete system, activate the checkbox **Complete PV system** in the area **Device selection**.
2. To display the values of individual inverters, perform the following steps:
3. Select the area **Device selection**
  - The area opens and the individual inverters are displayed.
4. Activate the checkboxes for the desired inverters.  
Tip: If you activate the checkbox **Select all devices**, the checkboxes for all inverters will be activated.

#### Selecting the display type:

- In the area **Device selection**, next to **Display type**, select the desired option:
  - Absolute**: Shows the system yield (kWh) or the system power (kW).
  - Specific**: Shows the specific system yield (kWh/kWp) or the specific system power.

## 14 Monitoring of the Sunny Home Manager system

The menu page **PV system monitoring** displays the following information depending on your system's configuration:

- Communication Monitoring
- Inverter comparison
- SMA Smart Connected
- System configuration

You can configure each of these ranges separately.





If an exclamation mark is displayed next to the System Monitoring menu item in the page and menu selection, you should open the page and check and fix the reason for the display.

### 14.1 Overview of system monitoring

#### 14.1.1 Communication Monitoring

Communication monitoring displays the current communication status between the Sunny Home Manager and Sunny Portal. If the Sunny Home Manager does not communicate with Sunny Portal within the set time, Sunny Portal will display an error and notify you by e-mail.



The communication monitoring status is displayed with the following symbols:

Symbol	Status	Explanation
	Disabled	Communication monitoring is not set.
	OK	Communication with Sunny Portal is OK. The time of last contact is displayed.
	Errors	Communication with Sunny Portal is interrupted. The <b>Details</b> link provides you with detailed information on the time of the last contact. The error will be displayed until it has been rectified. If the error is not corrected, Sunny Portal will send another e-mail reminder each day for up to three days after the first e-mail was sent.
	E-mail reminder is activated	Clicking the bell icon stops the sending of reminder e-mails for the current error. If a new error occurs, the e-mail reminder will be sent again.

#### 14.1.2 Inverter Comparison

The inverter comparison enables Sunny Portal to recognize possible yield losses. If the specific yield of an inverter differs significantly from the mean yield of all the inverters, Sunny Portal can notify you by e-mail. Since we are talking about PV yields, only PV and hybrid inverters play a role in this comparison.

Icon	Status	Explanation
	Disabled	No inverter comparison is active at present.

Icon	Status	Explanation
	Ok	The yields of the monitored inverters are within the configured range. The total yield of all inverters on the last day is displayed.
	Errors	The specific yield is outside the tolerance for at least 1 monitored inverter. You can access the following information via the <b>Details</b> link: <ul style="list-style-type: none"> <li>• Specific yield of the affected inverters</li> <li>• Average yield value of all monitored inverters</li> </ul>

### 14.1.3 SMA Smart Connected

SMA Smart Connected is a service free of charge from SMA Solar Technology AG that offers the following:

- Automatic inverter monitoring - your inverters are continuously checked for anomalies and errors.
- Automatic proactive notification in the event of a fault - following fault diagnosis and analysis you will be notified immediately via e-mail.
- Automatic replacement process - if the inverter has to be replaced, you will quickly receive a free replacement device.

In order to be able to participate in the Smart Connected program, you must give your approval.

### 14.1.4 System Configuration

The System Configuration field displays the number of devices detected as new in the system.

### 14.1.5 Further PV System Monitoring Options

#### System Logbook

The menu page **PV system logbook** shows you messages regarding the system status. These messages help you to identify disturbances in your PV system, for example.

You can filter messages and confirm that you have read the messages.

 You can find the number of unconfirmed messages right in the menu view of the page system logbook after the colon of the page name.

#### System report

On the menu page **Report** you can have the total yield and the meter changes of your system displayed as a summary table and in a diagram:

##### Daily System Report

- Table with meter change of the total yield for the current day, current month and current year
- Diagram with the development of the meter reading over the individual hours of a day

##### Monthly System Report

- Table with meter change of the total yield for the current month and current year
- Diagram with the development of the meter reading over the individual days of a month

You can have the reports sent by e-mail from Sunny Portal.

#### Machine

On the menu page **Devices** the data of the individual devices are displayed on their own page in clearly arranged diagrams.

- For **PV inverters**:



- Development of the meter reading (total yield in kWh) over the months of a year
- Development of the meter reading (total yield in kWh and power in kW) over the hours of a day
- For **Battery inverters**:
  - Current battery charging capacity over a selected period

If you require more detailed system monitoring functions and more comprehensive data storage, you have the option of activating additional functions via the SMA Online Store subject to a fee.

## 14.2 Configuring PV System Monitoring

### 14.2.1 Setting Communication Monitoring

The [**Settings**] button lets you select whether you want to monitor the communication between Sunny Portal and your system. If you would like monitoring, you can specify at what interval and how strictly this monitoring should take place.

**i** Sunny Portal can only display current data of the Sunny Home Manager and switch loads if the data request interval is set to **Automatic**.

#### Requirement:

- You must have the user role **Installer** or **PV System Administrator** (see Section 16.1, page 113).

#### Procedure:

1. In the area **Communication Monitoring**, select [**Settings**].
2. Click the slider below **Alerts** and, holding the left mouse button pressed, set the monitoring strength according to which Sunny Portal is to notify you by e-mail.  
These options can be selected: **off**, **liberal**, **tolerant** and **sharp**.
  - The result of the selected setting (time interval: 15 minutes) is shown in the column **Time**.
3. Enter the e-mail address(es) of the recipient(s) in the text field **Recipient**. If you enter several e-mail addresses, separate these by commas. (Only e-mail addresses already registered in Sunny Portal are authorized.)
4. Activate/deactivate monitoring for devices shown.
5. Click on [**Save**].

#### Setting the data request interval for the Sunny Home Manager:

The interval for the data request can be specified in the menu **Configuration** under **Device overview > Properties > Edit** (see Section 11.3.8, page 58) The options are automatic, hourly or daily.

**i** The Sunny Home Manager can only request data of the devices that have **Data request activated** (see Section 11.1.4, page 52).

### 14.2.2 Setting the Inverter Comparison

#### Requirements:

- There must be at least 2 inverters in the system that generate PV power.
- You must have the user role **Installer** or **PV System Administrator** (see Section 16.1, page 113).

#### Procedure:

1. In the area **Inverter comparison**, select [**Settings**].
2. Enter the e-mail address of the recipient in the text field **Recipient**. If you enter several e-mail addresses, separate these by commas.

3. The PV array power is preset in the text field **Generator capacity**. Sunny Portal calculates the PV array power based on the nominal power of each inverter.  
You can also enter the PV array power manually or have Sunny Portal calculate it if you have entered information on the strings before (see Section 10.2, page 40).
4. In the text field **Tolerance**, enter the permissible tolerance for the inverter's specific yield. This simultaneously sets the deviation of the inverter specific yield from which e-mail notification by Sunny Portal will be triggered.
5. To select an inverter for the inverter comparison, activate the checkbox **Monitoring** in the line of the inverter.
6. Click on [**Save**].

### 14.2.3 Activating SMA Smart Connected

**i** SMA Smart Connected can only be used in Sunny Portal when this feature is supported by the devices connected to the Sunny Home Manager.

In general, each device can be enabled for Smart Connected, however this must be carried out for each individual device and also for each individual country separately (manually).

In order to be able to participate in the Smart Connected program, you must give your approval.

For optimal use of the program, you should also provide the operator and installer data, the delivery address for any replacement that may be required, and the e-mail address of the recipient of the monitoring data.

#### Procedure:

1. In the menu **System monitoring** click on [**Settings**] in the field SMA Smart Connected.  
 The device properties of the product that supports the SMA Smart Connected function opens.
2. Select [**Edit**].
3. In the field **SMA Smart Connected** place a checkmark to give approval.
4. Click on [**Save**].

#### Alternative procedure:

1. Call up the menu page **Configuration > Device overview**.
2. Select the device that supports the SMA Smart Connected function and call up **Properties**.
3. Select [**Edit**].
4. In the field **SMA Smart Connected** place a checkmark to give approval.
5. Click on [**Save**].

### 14.2.4 Editing the System Configuration



#### Requirements for displaying this page:

- At least 1 new device must have been detected in the system.

In the page and menu selection, an exclamation mark next to the **System monitoring** menu item indicates that at least 1 new device has been detected in the system.

You do not have to configure a newly detected device immediately, but can do so at a later time.

### Configure new device

- In the system configuration field, select **Set up devices now >>**.
  - You are forwarded to the tab **Overview of new devices** in the menu **Configuration > Device overview** (see Section 11.2.2, page 54).
- Select the required device. Then, in the Configuration column, select either the  to add the new device to the installation or the  to add the new device to the installation as a replacement device.
  - The configuration wizard opens and guides you through the further steps.
  - When all new devices have been configured, the System Configuration field on the System Monitoring tab will no longer be displayed.

When all new devices have been configured, the exclamation mark next to the menu item System Monitoring should also disappear.

#### Delete unwanted exclamation mark:

If you are bothered by the exclamation mark next to the **System monitoring** menu item, which is there to remind you of this pending action, you can delete it by going to **Configuration > Device overview** and removing all newly detected devices that have not yet been configured (see Section 11.2.2, page 54).

 If the exclamation mark is still displayed next to the System Monitoring menu item, this indicates that either the data reception or the inverter comparison has a communication problem.

### 14.2.5 Filter and confirm messages in the system logbook

In the upper area of the page **PV system logbook** there are different fields to filter the messages that are listed in the following table. This filtering only allows you to call up certain messages.

You can confirm messages in order to mark them as read. This will help you to differentiate between old and new messages.

#### Filtering Messages:

- Select **PV System Logbook** in the page and menu selection.
- To filter messages, set one or more of the following filters:

Input field or drop-down list	Explanation
Go to	The date for the current day is preset. With the arrows on the left and right you can go back any number of days or proceed again. In the table in the column <b>Time</b> all messages up to and including this day are shown.
Type	The following message types are available: <ul style="list-style-type: none"> <li>• <b>Information message</b></li> <li>• <b>Warning</b></li> <li>• <b>Event message</b></li> <li>• <b>Error</b></li> <li>• <b>Other</b></li> </ul> To display messages of a specific type, activate the appropriate checkbox(es). The desired messages are displayed in the column <b>Type</b> with the respective symbol and further explained in the column <b>Description</b> .

Input field or drop-down list	Explanation
Status	<p>In the drop-down menu you can either call up all messages or just the ones that are new or that you already read:</p> <ul style="list-style-type: none"> <li>• <b>Not approved</b> messages: new ✖</li> <li>• <b>Approved</b> messages: read ✔</li> <li>• <b>all</b></li> </ul> <p>In the table, the status is displayed in the <b>Confirmed</b> column with the corresponding symbol.</p>
System/Devices	<p>The portal, the system and all devices of your system are listed in the drop-down list.</p> <ul style="list-style-type: none"> <li>• To display the messages in Sunny Portal, the Sunny Home Manager system and the devices, select <b>All</b>.</li> <li>• To only display messages of a specific product, select the respective product (e.g. <b>SB4.0-1A-41</b>).</li> </ul> <p>The selected product can be found in the column <b>PV system/Devices</b> in the table.</p>

### Confirming messages:

#### Requirement:

- You must have the user role **Installer** or **PV System Administrator** (see Section 16.1, page 113).
  1. To confirm individual messages, select ✖ in the required message line and the column **Confirmed**.
  2. To confirm all messages check the checkbox **Confirm all** above the table.

## 14.2.6 Configuring Reports

#### Requirement:

- You must have the user role **Installer** or **PV System Administrator** (see Section 16.1, page 113).

You can configure different types of event reports, each with different content:

Report, type	Possible content
3 x daily info report	<ul style="list-style-type: none"> <li>• Yield (kWh) in the selected time period</li> </ul>
3 x monthly info report	<ul style="list-style-type: none"> <li>• Maximum power (kW) in the selected time period</li> <li>• CO<sub>2</sub> avoided (kg) in the selected time period</li> <li>• Feed-in tariff in the selected time period, if applicable</li> <li>• Diagram of the page <b>Energy balance</b> for the selected time period (only with PDF delivery)</li> </ul>
3x event report	<ul style="list-style-type: none"> <li>• Information</li> <li>• Warnings</li> <li>• Disturbances</li> <li>• Error</li> </ul>
1x event report for standard	<p>Message regarding grounding errors, residual current and the grid disconnecting device</p> <ul style="list-style-type: none"> <li>• AS 5033</li> <li>• DIN EN 62109-2 / IEC 62109-2</li> </ul>

In addition, you can create a report for a specific date in the past.

## Configuring Info Reports

Sunny Portal sends you the Daily info reports when it has processed all the data from the previous day, and the Monthly info report at the end of the month.

### Requirement:

- You must have entered the CO<sub>2</sub> avoided factor (see Section 10.4.8, page 48).

### Procedure:

1. In the drop-down list **Report Configuration**, select a **Daily info report** or a **Monthly info report**.
2. Select [**Edit**].
3. In the field **Activate report**, activate the checkbox **Active**.
4. Under **Recipient**, enter the e-mail address(es) of the recipient(s) in the text field **E-mail address(es)**. If you enter several e-mail addresses, separate these by commas.
5. In the **Contents** area at **Select channel(s)**, activate the contents that is to be displayed in the e-mail.
6. At **Send report as** select the format in which Sunny Portal is to send the report: text, HTML format or PDF.
7. At **Portal page to be sent**, in the drop-down list either select the page that the Sunny Portal is to sent along with the report or select **Send no page**.
8. To send a test report to the stated e-mail address, select [**Send test report**].
9. Click on [**Save**].

## Configuring Event Reports

Sunny Portal sends you the event reports at the times set.

### Procedure:

1. In the drop-down list **Report configuration**, select an **Event report**.
2. Select [**Edit**].
3. In the field **Activate report**, activate the checkbox **Active**.
4. Under **Recipient**, enter the e-mail address(es) of the recipient(s) in the text field **E-mail address(es)**. If you enter several e-mail addresses, separate these by commas.
5. In the **Interval** area, first specify how often you wish to receive an event report by e-mail by either activating the option **Hourly** or **Daily**, and then select from the drop-down list the **Time** you would like to receive the e-mail.
6. In the **Contents** area activate the event types whose contents are to be displayed in the e-mail.  
The Sunny Portal and the Sunny Home Manager system each offer 4 event types: information, warnings, failures and errors.
7. At **Send report as** select the format in which Sunny Portal is to send the report: text, HTML format or PDF.
8. At **Limit messages in one report**, use the drop-down list to select the maximum number of messages to be displayed in the e-mail.
9. If applicable, activate **Send empty reports if no new events are available** if you wish to have sent reports even if there are no new events available.
10. To send a test report to the stated e-mail address, select [**Send test report**].
11. Click on [**Save**].

## Manually Regenerating Reports

You can create a report for a specific date in the past.

**Procedure:**

1. Select the desired report in the drop-down list **Report configuration**.
2. In the field **Report date** in the area **Regenerate report manually**, enter the date for which you wish to create a report, either manually or using the calendar.
3. Select [**Generate**].
  - A message that the report has been successfully sent is displayed.

## 15 Presentation of the Sunny Home Manager system

### 15.1 PV System Profile

Sunny Portal compiles the PV system profile from information that you can enter or have entered in different Sunny Portal pages. Thus, the system profile is extensive.

Basically, the profile shows your system's data in three fields, a system image (optional) in another field to the right of it and, if you configure or have configured this, a summary description in a text block below these fields.

The following information can be displayed in the PV system profile:

Position	Information
Field on top	<ul style="list-style-type: none"> <li>• Location</li> <li>• Operator (optional)</li> <li>• Commissioning</li> </ul>
Field center	<ul style="list-style-type: none"> <li>• Nominal system power</li> <li>• Annual production</li> <li>• CO<sub>2</sub> avoided</li> <li>• Nominal battery capacity (only displayed for PV systems with battery)</li> <li>• Battery type (only displayed for PV systems with battery)</li> </ul>
Field bottom	<ul style="list-style-type: none"> <li>• Communication - Sunny Portal receives this information from the devices.</li> <li>• Modules (optional)</li> <li>• Inverter (optional)</li> </ul>
Field on the right	Image of e.g. the system (optional)
Text block	System description (optional)

You can change the individual data in the system profile at any time (see Section 10.1, page 38).

You can make the system profile available for viewing to third parties and incorporate it in your own web presence.

### 15.2 Make PV system profile publicly available

On the menu page **PV system presentation** the source text is shown in the field **PV system profile**.

Clicking on the button [**Preview**] displays the stored PV system profile. You can incorporate this PV system profile in your web presence by copying and pasting the source text into your web presence.

Changes to your PV system profile can be made in **Configuration** under **PV system properties > PV system data**.

### 15.3 Releasing and publishing pages

With Sunny Portal you can present your PV system to third parties.

- You can make selected Sunny Portal pages of your PV system available for viewing on sunnyportal.com and send links on these pages by e-mail to interested persons.
- You can set a link to your Sunny Portal page on other websites.

The following Sunny Portal pages can be selected for release or for linking:

- System profile
- System overview
- Annual comparison

**Requirement:**

- You must have the user role **Installer** or **PV System Administrator** (see Section 16.1, page 113).

**Releasing Pages for Viewing in Sunny Portal**

- You must have published at least one page.

**Procedure:**

1. In the field **Publicly available area** click on the link **Open publicly available area of this PV system** to see which pages you have released so far (usually at least the PV system profile).
2. Click on the button **[Send the website by e-mail]**.
3. Enter the e-mail address of the recipient and (optional) a message for the recipient.
4. **[Send e-mail]**.

**Presenting Sunny Portal Pages on the Internet**

Each of your Sunny Portal pages has its own URL. Using these URLs, you can set a link to your Sunny Portal page on other websites.

**Procedure:**

1. Select the desired page in the page and menu selection.
2. In the contents area, select **[Configuration - "Name of the page"]**.
3. To view a preview of the page, select **Open page in a new window**.
4. Copy the URL from the **URL of the Page** field onto the clipboard.
5. Copy the URL from the clipboard to a program for creating websites (e.g. Microsoft Office Frontpage) or integrate it into your own website by means of an inline frame.

## 15.4 Specifying the System Home Page

In the field **System home page** you can specify which Sunny Portal page is to be displayed first for your PV system upon login or after switching PV systems.

1. From the drop-down menu select one of the menu pages of your Sunny Home Manager system as the home page.
2. Click on **[Save]**.



## 16 User Management

### Requirements for displaying the page:

- You must be a **System administrator**.

This page displays all users created for the Sunny Home Manager system (see Section 16.2, page 114). You can also edit previously created users and, for example, change the user roles or delete users.

### 16.1 User Groups and User Rights

If you have the user role **PV system administrator**, you can create further users in Sunny Portal so that they have access to your Sunny Portal system. You can assign various roles to users. The roles are differentiated by the rights they grant to users in your Sunny Portal system. The following roles are possible:

- Guest
- Standard user
- Installer
- System administrator

Rights	Role			
	Guest	Standard user	Installer	System administrator
Log in	✓	✓	✓	✓
View pages	✓	✓	✓	✓
Change and delete pages	–	–	✓	✓
Release pages for viewing in Sunny Portal and publish pages	–	–	✓	✓
View live data	–	✓	✓	✓
Save diagram data	–	✓	✓	✓
View and change user information	✓	✓	✓	✓
Changing the Sunny Portal Password	–	✓	✓	✓
Changing the System Password	–	–	✓	✓
View system properties	–	✓	✓	✓
Change system properties	–	–	✓	✓
View report configuration	–	✓	✓	✓
Change report configuration	–	–	✓	✓
View and read out device properties	–	✓	✓	✓
Change device properties	–	–	✓	✓
Add and configure switching devices (radio-controlled sockets, Modbus devices)	–	✓	✓	✓
Set the operating mode of switching devices via Sunny Portal	–	✓	✓	✓

Rights	Role			
	Guest	Standard user	Installer	System administrator
Add and configure loads (EEBus / SEMP devices)	–	✓	✓	✓
Replace Sunny Home Manager	–	–	✓	✓
Delete Sunny Home Manager	–	–	✓	✓
Reassign the Sunny Home Manager to the system	–	–	✓	✓
Delete the Sunny Home Manager system	–	–	–	✓
Add an inverter	–	–	✓	✓
Replace an Inverter	–	–	✓	✓
Delete inverter	–	–	✓	✓
Set inverter comparison	–	–	✓	✓
Set communication monitoring	–	–	✓	✓
Set the meter configuration	–	–	✓	✓
View the PV system logbook	–	✓	✓	✓
Confirm entries in the PV system logbook	–	–	✓	✓
Import data	–	–	✓	✓
Read off the software package version	–	✓	✓	✓
View user management	–	–	–	✓
Create and delete users and assign roles	–	–	–	✓

## 16.2 Creating a New User

### Procedure:

1. Select **Configuration > User management** in the page and menu selection.
  2. Select [**New User**].
  3. Enter the e-mail address of the new user in the text field **E-mail address**.
  4. Activate the desired role option in the area **Roles**.
  5. Click on [**Save**].
- The new user receives an e-mail with the access data.

## 16.3 Deleting a User

### Procedure:

1. Select **Configuration > User management** in the page and menu selection.
2. In the user line and the column **Delete**, select .
3. Confirm the security prompt with [**Yes**].

## 16.4 Changing User Rights

### Procedure:

1. Select **Configuration > User management** in the page and menu selection.
2. In the user line and the column **Edit**, select .
  - The areas **E-mail Address** and **Roles** open.
3. Activate the desired role option in the area **Roles**.
4. Click on [**Save**].
  - The user rights are changed for the Sunny Home Manager system.

## 16.5 Changing User Information

Every user can enter user information. User information includes, for example, the user's name and address.

### Procedure:

1. Select **User Info/Logout > User information** in the page and menu selection.
2. Select [**Edit**].
  - The menu for setting user information opens.
3. Enter the user information.
4. Click on [**Save**].

## 17 Password Information

### 17.1 Requirements for a Secure System Password

Rules to increase the security of your password:

Select passwords containing **at least 10 characters and no more than 50 characters**, including

- at least a lowercase letter
- at least an uppercase letter
- at least a digit and
- at least one of the following permitted special characters: (!\"\$%&/()=?\*+##\_.;;<>|{}[]^`~)

### 17.2 Required Passwords

#### Sunny Portal Password

If you register a PV system in Sunny Portal, you must specify a Sunny Portal password during registration which you will use to log in to Sunny Portal.

#### Sunny Portal password requirements:

- The Sunny Portal password must contain **at least 10 characters and no more than 50 characters**. The strict rules previously stated apply.

#### System Password

All devices connected via Speedwire with the same password form a system. For this reason, a password used for all devices in a system is called a system password. The system-specific password protects a system's communication.

You can only access the devices in your PV system via your communication product if all devices have the same password.

You must define the system password in Sunny Portal when you register the Sunny Home Manager system. The system password that you defined upon registration of the Sunny Home Manager is the password of the user group **Installer**.

#### System and installer password requirements:

The system-specific system password must consist of **at least 8 characters and no more than 12 characters**, including

- at least a lowercase letter
- at least an uppercase letter
- at least a digit and
- at least one of the following permitted special characters: ? \_ ! -

#### Password for Edimax radio-controlled sockets

The same password must be used for all Edimax radio-controlled sockets in the system that require a password. If there are different passwords for the radio-controlled sockets, the Sunny Home Manager cannot control all radio-controlled sockets.

Make sure that the shared password is entered at the following positions:

- In the separate Edimax app for each radio-controlled socket registered there
- In the Sunny Home Manager properties (see Section 11.3.6, page 58)

## FRITZ!Box password

There is no separate password for AVM FRITZ!DECT products, Communication of the Sunny Home Manager takes place indirectly via the FRITZ!Box. For this, a FRITZ!Box password is required depending on the set login. To set up the Smart Home control in the Sunny Home Manager, as of FRITZ!OS version 7.26, both a user name and a password must be entered to log in to the FRITZ!Box (see Section 11.3.4, page 57).

Make sure that the settings for the FRITZ!Box login in the home network are the same in the FRITZ!Box and in the Sunny Home Manager.

## 17.3 Changing Passwords

### Changing the Sunny Portal Password

#### Requirement:

- You must be a **Standard user**, **Installer** or **PV system administrator** (see Section 16.1, page 113).

#### Procedure:

1. Select **User Info/Logout > Personal data** in the page and menu selection.
2. On the tab **Personal data**, select the hyperlink **If you want to change your password, please click here**.
3. Enter the old and the new Sunny Portal passwords in the designated text fields.
4. Click on [**Save**].

### Changing the System and Installer Passwords

#### Requirement:

- You must have the user role **Installer** or **PV System Administrator** (see Section 16.1, page 113).

#### Procedure:

1. Call up the device properties of the Sunny Home Manager (see Section 11.3, page 56).
2. Select [**Edit**].
  - The menu for setting the device properties opens.
3. Enter a new password in the **PV system password** field.
4. Enter the new password again in the field **Repeat password**.
5. Click on [**Save**].
  - The Sunny Home Manager changes the password for all devices.

## 17.4 Procedure in Case of Forgotten Passwords

### Sunny Portal Password Forgotten

1. Go to **www.sunnyportal.com**.
2. In the **Login** area, select the **Forgotten password** link.
3. Enter your e-mail address in the **E-mail** field.
4. Select [**Generate New Password**].
  - You will receive an e-mail with a new password.
5. Change the assigned password (see Section 17.3, page 117).

### System Password Forgotten

Activate each device with a personal unlocking key (PUK).

**Forgotten password for Edimax Wi-Fi radio-controlled sockets**

See manufacturer's manual.

**Forgotten password for the Fritz!Box**

See manufacturer's manual.

## 18 Troubleshooting

First, ensure that all devices in your PV system have the latest firmware version.

You will find answers to frequently asked questions in the Sunny Portal in the footer under **FAQ** or on the website <https://my.sma-service.com/>

### 18.1 Error message on the Sunny Home Manager

LED status	Cause and corrective measures
Status LED: off	<p>The Sunny Home Manager is not supplied with voltage.</p> <p><b>Corrective measures:</b></p> <ul style="list-style-type: none"> <li>• Connect the Sunny Home Manager to the voltage supply (see Section 8.2, page 24).</li> </ul>
Status LED: flashing red	<p>The Sunny Home Manager cannot establish the connection to Sunny Portal automatically.</p> <p><b>Corrective measures:</b></p> <ul style="list-style-type: none"> <li>• Use the Sunny Home Manager Assistant (see Section 18.6, page 129).</li> </ul>
Performance LED: off	<p>The Sunny Home Manager has not been registered in Sunny Portal yet.</p> <p><b>Corrective measures:</b></p> <ul style="list-style-type: none"> <li>• Register the Sunny Home Manager in Sunny Portal (see Section 9.1, page 30).</li> </ul> <p>If the Sunny Home Manager is used as an energy meter, it does not have to be registered - and the performance LED never glows.</p>
Performance LED: glowing red	<p>The Sunny Home Manager cannot establish the connection to Sunny Portal automatically. One or several of the devices in the system is/are in a fault state. This could not be reported yet to Sunny Portal due to the connection failure.</p> <p><b>Corrective measures:</b></p> <ul style="list-style-type: none"> <li>• Check connection and configuration of all devices in the system.</li> </ul>
Performance LED: flashing red	<p>The Sunny Home Manager cannot establish the connection to Sunny Portal automatically.</p> <p><b>Corrective measures:</b></p> <ul style="list-style-type: none"> <li>• Ensure that the Sunny Home Manager is correctly connected to the router (see Section 8.3.2, page 27).</li> <li>• Use the Sunny Home Manager Assistant (see Section 18.6, page 129).</li> </ul>

## 18.2 Problems during Registration with the System Setup Assistant

Problem	Cause and corrective measures
When logging in as a user in Sunny Portal, you do not receive an e-mail containing a link and your access data to Sunny Portal.	<p>The e-mail may have landed in a spam mail folder.</p> <p><b>or</b></p> <p>The e-mail may have been sent to a different e-mail address.</p> <p><b>Corrective measures:</b></p> <ul style="list-style-type: none"> <li>• Check if the e-mail accidentally landed in a folder other than the one you expected.</li> <li>• If the e-mail was accidentally sent to someone else's e-mail address, restart the system setup assistant and re-enter the registration data.</li> </ul>
The system setup assistant cannot find any Sunny Home Manager with the entered identification and registration ID.	<p>The serial number and/or the registration ID may have been entered incorrectly.</p> <p><b>Corrective measures:</b></p> <ul style="list-style-type: none"> <li>• Ensure that the entries are correct.</li> </ul>
The system setup assistant cannot find any Sunny Home Manager with the entered identification and registration ID.	<p>It is possible that the registration procedure was previously initiated but not completed.</p> <p><b>Corrective measures:</b></p> <ul style="list-style-type: none"> <li>• Perform a complete reset of the Sunny Home Manager (see Section 11.7.1, page 66).</li> </ul>
The system setup assistant cannot find any Sunny Home Manager with the entered identification and registration ID.	<p>It is possible that the Sunny Home Manager is not properly connected to the router.</p> <p><b>Corrective measures:</b></p> <ul style="list-style-type: none"> <li>• Ensure that the Sunny Home Manager is correctly connected to the router (see Section 8.3.2, page 27).</li> </ul>
The system setup assistant cannot find any Sunny Home Manager with the entered identification and registration ID.	<p>DHCP is possibly not activated on your router or there is a proxy server in your network. For this reason, Sunny Home Manager cannot establish a connection to Sunny Portal.</p> <p><b>Corrective measures:</b></p> <ul style="list-style-type: none"> <li>• Establish the connection to Sunny Portal using the Sunny Home Manager Assistant (see Section 18.6, page 129).</li> </ul>
The system setup assistant cannot find any Sunny Home Manager with the entered identification and registration ID.	<p>The Sunny Home Manager might have already been assigned to a system in Sunny Portal with your e-mail address.</p> <p><b>Corrective measures:</b></p> <ul style="list-style-type: none"> <li>• Delete the Sunny Home Manager from the PV system (see Section 11.9, page 68).</li> </ul>
The system setup assistant cannot find any Sunny Home Manager with the entered identification and registration ID.	<p>The Sunny Home Manager might have already been assigned to a different system in Sunny Portal, for instance, if you have bought the Sunny Home Manager second-hand.</p> <p><b>Corrective measures:</b></p> <ul style="list-style-type: none"> <li>• If possible, contact the previous owners and ask them to delete the Sunny Home Manager system in Sunny Portal.</li> </ul>



Problem	Cause and corrective measures
The system setup assistant cannot establish a connection to the Sunny Home Manager.	<p>It is possible that the Sunny Home Manager is not properly connected to the router.</p> <p><b>Corrective measures:</b></p> <ul style="list-style-type: none"> <li>• Ensure that the Sunny Home Manager is correctly connected to the router (see Section 8.3.2, page 27).</li> </ul>
The system setup assistant cannot establish a connection to the Sunny Home Manager.	<p>DHCP is possibly not activated on your router or there is a proxy server in your network. For this reason, Sunny Home Manager cannot establish a connection to Sunny Portal.</p> <p><b>Corrective measures:</b></p> <ul style="list-style-type: none"> <li>• Establish the connection to Sunny Portal using the Sunny Home Manager Assistant (see Section 18.6, page 129).</li> </ul>
The system setup assistant cannot establish a connection to the Sunny Home Manager.	<p>The Sunny Home Manager might have already been assigned to a system in Sunny Portal with your e-mail address.</p> <p><b>Corrective measures:</b></p> <ul style="list-style-type: none"> <li>• Delete the Sunny Home Manager from the PV system (see Section 11.9, page 68).</li> </ul>
The system setup assistant cannot establish a connection to the Sunny Home Manager.	<p>The Sunny Home Manager might have already been assigned to a different system in Sunny Portal, for instance, if you have bought the Sunny Home Manager second-hand.</p> <p><b>Corrective measures:</b></p> <ul style="list-style-type: none"> <li>• If possible, contact the previous owners and ask them to delete the Sunny Home Manager system in Sunny Portal.</li> </ul>
The system setup assistant cannot establish a connection to the Sunny Home Manager.	<p>It is possible that the Sunny Home Manager is not correctly connected to the router.</p> <p><b>or</b></p> <p>It is possible that the Sunny Home Manager is not supplied with voltage. In this case, all LEDs on the Sunny Home Manager will be off.</p> <p><b>Corrective measures:</b></p> <ul style="list-style-type: none"> <li>• Ensure that the Sunny Home Manager is correctly connected to the router (see Section 8.3.2, page 27).</li> <li>• Ensure that the Sunny Home Manager is supplied with voltage.</li> <li>• If the Sunny Home Manager is correctly connected to the router and is supplied with voltage but all LEDs remain off, contact Service.</li> </ul>
The system setup assistant cannot establish a connection to the Sunny Home Manager.	<p>It is possible that the SMA device is not correctly connected to the router or is not supplied with voltage.</p> <p><b>Corrective measures:</b></p> <ul style="list-style-type: none"> <li>• Ensure that the SMA device is correctly connected to the router and is supplied with voltage (see SMA device documentation).</li> </ul>

Problem	Cause and corrective measures
The system setup assistant cannot establish a connection to the Sunny Home Manager.	<p>The SMA device might have already been registered in Sunny Portal via Webconnect.</p> <p><b>Corrective measures:</b></p> <ul style="list-style-type: none"> <li>• Delete the SMA device from the Webconnect system or deactivate the data reception of the device in the Webconnect system.</li> </ul>
The system setup assistant cannot establish a connection to the Sunny Home Manager.	<p>The SMA device might not be located in the same local network as the Sunny Home Manager.</p> <p><b>Corrective measures:</b></p> <ul style="list-style-type: none"> <li>• Connect the SMA device to the same router/network switch as the Sunny Home Manager.</li> </ul>
The system setup assistant cannot establish a connection to the Sunny Home Manager.	<p>The network cable that connects the SMA device to the router/network switch might not be suitable for 100 MBit/s.</p> <p><b>Corrective measures:</b></p> <ul style="list-style-type: none"> <li>• Use a network cable suitable for Speedwire (for network cable requirements, see the Speedwire device documentation).</li> </ul>
The system setup assistant cannot establish a connection to the Sunny Home Manager.	<p>It may be that DHCP has not been activated in your router.</p> <p><b>Corrective measures:</b></p> <ul style="list-style-type: none"> <li>• Activate DHCP in the router.</li> <li>• If your router does not support DHCP, configure the static network settings on the Speedwire device using SMA Connection Assist. You can obtain the SMA Connection Assist software free of charge from the download area at <a href="http://www.SMA-Solar.com">www.SMA-Solar.com</a>.</li> </ul>
The system setup assistant cannot establish a connection to the Sunny Home Manager.	<p>The router/network switch used in the network might have deactivated the LAN ports when they appear to be inactive in order to save energy. As a result, it is not possible to establish any connection to the SMA device.</p> <p><b>Corrective measures:</b></p> <ul style="list-style-type: none"> <li>• Configure the router/network switch so that the LAN ports are not deactivated.</li> </ul>
The system setup assistant lists none or not all of the new SMA devices that are connected via Speedwire/Ethernet.	<p>It is possible that the function "IGMP Snooping" is activated in the switch used in the network. In this case this means that the connection to the SMA device is interrupted due to apparent inactivity, and cannot be subsequently restored.</p> <p><b>Corrective measures:</b></p> <ul style="list-style-type: none"> <li>• Deactivate the "IGMP snooping" function in the network switch if this is possible. Otherwise, replace the network switch.</li> </ul>
The system setup assistant lists none or not all of the new SMA devices that are connected via Speedwire/Ethernet.	<p>The firewall or IP filter may not have been configured correctly.</p> <p><b>Corrective measures:</b></p> <ul style="list-style-type: none"> <li>• Adjust the firewall or IP filter settings (see firewall- or router documentation).</li> </ul>

Problem	Cause and corrective measures
<p>After you have entered the system password and added devices, some devices are shown with a warning symbol in the system setup assistant.</p>	<p>There is a different installer password configured in the devices with warning symbols.</p> <p><b>Corrective measures:</b></p> <ol style="list-style-type: none"> <li>1. Select [<b>Skip forward</b>] in the system setup assistant and finish registration without selecting the devices.</li> <li>2. Set a uniform installer password for all devices via the inverter user interface.</li> <li>3. If you do not know the password set on each device, apply for a Personal Unlocking Key (PUK) for each device from the Service (see Section 23, page 140).</li> <li>4. Enable each device with the corresponding PUK. Then set a uniform installer password in all devices.</li> <li>5. Log in to Sunny Portal and add the devices to the Sunny Home Manager system as new devices using the configuration wizard.</li> </ol>
<p>While the system setup assistant is performing the device search, the status LED of the Sunny Home Manager first flashes red for 1 to 2 minutes. Subsequently, the status LED glows green again.</p>	<p>Device detection takes a few minutes longer.</p> <p><b>Corrective measures:</b></p> <ul style="list-style-type: none"> <li>• No measures required.</li> </ul>

## 18.3 Problems with Integration of Devices

Problem	Causes and remedies
<p>The Sunny Home Manager does not detect any devices.</p>	<p>The devices must be connected to the local router via Ethernet/Wi-Fi and also be able to communicate with the Sunny Home Manager:</p> <p><b>Corrective measures:</b></p> <ul style="list-style-type: none"> <li>• All Ethernet/Wi-Fi devices in your PV system must be in operation.</li> <li>• The Ethernet/Wi-Fi devices must be connected to the router/network switch correctly.</li> <li>• The network cable connecting the Ethernet devices with the router/network switch must be suitable for 100 MBit/s.</li> <li>• The Ethernet devices must be in the same local network as Sunny Home Manager.</li> <li>• DHCP must be activated on the router.</li> <li>• The router must have an Internet connection.</li> <li>• For Ethernet devices with integrated Bluetooth interface, the NetID of 0 must be set. In this way, Bluetooth is deactivated.</li> <li>• The LAN ports on the router / network switch may not be switched off in the event of apparent inactivity (see router / network switch manual).</li> <li>• The network switch may not use IGMP snooping (see network switch manual).</li> </ul>

Problem	Causes and remedies
When you <b>register a new device</b> with the configuration wizard, the error message <b>Connection failed</b> appears.	<p>A password other than the standard password 1111 or than the system password of the existing system may have been set for the new device.</p> <p><b>Corrective measures:</b></p> <ul style="list-style-type: none"> <li>Temporarily change the system password of the existing system to the password of the new SMA device (see Section 17.3, page 117).</li> </ul>
After a <b>Device replacement</b> using the configuration wizard, the current parameters are not displayed in the parameter list.	<p>It is possible that the new parameters have not yet been transferred to Sunny Portal.</p> <p><b>Corrective measures:</b></p> <ul style="list-style-type: none"> <li>Call up the parameter list again later.</li> </ul>
After <b>Pairing</b> , the new <b>EESBus device</b> is not displayed in Sunny Portal.	<p>Pairing might have taken too long; the time window of 2 minutes was exceeded.</p> <p><b>Corrective measures:</b></p> <ul style="list-style-type: none"> <li>Repeat the pairing of the load and Sunny Home Manager.</li> </ul>
After <b>Pairing</b> , the new <b>EESBus device</b> is not displayed in Sunny Portal.	<p>The Sunny Home Manager may have connected to another EESBus device.</p> <p><b>Corrective measures:</b></p> <ul style="list-style-type: none"> <li>The new EESBus device can be identified by the serial number. Check the serial numbers of the devices connected to the Sunny Home Manager in the device management (see Section 11.1, page 50) and (see Section 11.2, page 52).</li> <li>Repeat the pairing with the required load.</li> </ul>
In the portal, not all <b>LED lamps</b> that can be controlled by the Sunny Home Manager are displayed in the drop-down list for the status display in the <b>AVM FRITZ!Box Smart Home control</b> area. I cannot select the LED lamp I want.	<p>The LED lamps are registered in the FRITZ!Box. There you can assign an individual name for each LED lamp. This is read out by the Sunny Home Manager and displayed together with the specific identification number in the portal in the AVM FRITZ!Box Smart Home control area.</p> <p>You may have entered too many characters when naming the individual LED lamps.</p> <p><b>Corrective measures:</b></p> <ul style="list-style-type: none"> <li>Choose a short name for the naming of the LED lamps in the FRITZ!Box. Use as few special characters as possible.</li> </ul>
In the portal, the line <b>Current status display via:</b> is not displayed in the <b>AVM FRITZ!Box Smart Home control</b> area.	<p>You may have exceeded the character length specified as the maximum when registering the LED lamps.</p> <p><b>Corrective measures:</b></p> <ul style="list-style-type: none"> <li>Choose a short name for the naming of the LED lamps in the FRITZ!Box. Use as few special characters as possible.</li> </ul>

## 18.4 Problems with Data Update

### Firmware and device update, restart

Problem	Cause and corrective measures
The automatic firmware update is not working and there is a corresponding error message.	<p>The Sunny Home Manager may not be able to establish a connection to the SMA Update Portal because there is a proxy server in your network.</p> <p><b>Corrective measures:</b></p> <ul style="list-style-type: none"> <li>• Configure the settings of your network in such a way that the SMA Update Portal <a href="https://Update.SunnyPortal.de">https://Update.SunnyPortal.de</a> can be reached.</li> </ul>
New firmware is not updated.	<p>The firmware update is always a 2-step process. First, it is downloaded and installed. At this point, the message "Update successful..." already appears.</p> <p>The update is only active after a reboot, which the Sunny Home Manager performs the night after the update.</p> <p><b>Corrective measures:</b></p> <ul style="list-style-type: none"> <li>• Check the update again later.</li> <li>• If necessary, perform a manual device reboot (as per the device manual).</li> </ul>
Device updates are not being loaded.	<p>Some devices can only get their update directly since the update file is too large.</p> <p><b>Corrective measures:</b></p> <ul style="list-style-type: none"> <li>• Check the status or event messages of the affected device. If necessary, perform a manual device update (as per the device manual).</li> </ul>
Restarting the Sunny Home Manager does not work.	<p>It is possible that the device cannot be accessed.</p> <p><b>Corrective measures:</b></p> <ul style="list-style-type: none"> <li>• Reconnect the device and perform the restart again (see Section 11.8, page 68).</li> <li>• In an emergency, you can also trigger the restart directly on the Sunny Home Manager: Press and hold the reset button on the device with a pointed object until the LEDs stop flashing red (at least 6 seconds).</li> </ul>

## Incomplete / outdated / faulty data on the user interface

Problem	Cause and corrective measures
<p>Data on the following pages is not up to date:</p> <ul style="list-style-type: none"> <li>• <b>Current Status And Forecast</b></li> <li>• <b>Energy balance</b> on the <b>Current</b> tab</li> <li>• <b>Load balance and control</b> on the <b>Current</b> tab</li> </ul>	<p>Settings in the router might prevent Sunny Portal from requesting current data from the Sunny Home Manager.</p> <p><b>Corrective measures:</b></p> <ul style="list-style-type: none"> <li>• Ensure that the following requirements are fulfilled <ul style="list-style-type: none"> <li>- All UDP ports &gt; 1024 on the router or modem must be open for outgoing connections. If there is a firewall installed on the router or modem, you may need to adjust the firewall rules.</li> <li>- It must be possible for the outgoing router or modem connections to reach all Internet destinations (target IP, target port). If there is a firewall installed on the router or modem, you may need to adjust the firewall rules.</li> <li>- On the router or modem with NAT (Network Address Translation) there must not be any port forwarding. Potential communication problems can thus be prevented.</li> <li>- There must be no packet filtering or manipulation for SIP packets installed on the router or modem.</li> </ul> </li> </ul>
<p>The page <b>Energy Balance</b> is not displayed.</p>	<p>The <b>Energy balance</b> page is only displayed if the integrated measuring device or a separate SMA Energy Meter supplies measurement data from the grid-connection point.</p> <p><b>Corrective measures:</b></p> <ul style="list-style-type: none"> <li>• Ensure that a measuring device is installed at the grid-connection point. Assign the measuring device (integrated or separate SMA Energy Meter) to the point of interconnection in the Sunny Home Manager properties (see Section 11.3.11, page 61).</li> </ul>
<p>On the pages <b>Energy balance</b> and <b>Load balance and control</b>, the <b>Current</b> tab is not displayed.</p>	<p>The tab is only displayed if the data request interval is set to <b>Automatic</b>.</p> <p><b>Corrective measures:</b></p> <ul style="list-style-type: none"> <li>• Set the data request interval to <b>Automatic</b> (see Section 11.3.8, page 58).</li> </ul>
<p>Sunny Portal is not showing any weather forecast in the diagram <b>Forecast and recommended action</b>.</p>	<p>It can take up to 24 hours after the Sunny Home Manager has been initially registered in Sunny Portal until the weather forecast is displayed.</p> <p><b>Corrective measures:</b></p> <ul style="list-style-type: none"> <li>• After 24 hours, check again to see whether the weather forecast is displayed.</li> <li>• If after 24 hours there is still no weather forecast displayed, contact the Service team (see Section 23, page 140).</li> </ul>
<p>The animated graphic on the page <b>Current status and Forecast</b> is not displaying any current data.</p>	<p>The reception of current data from the Sunny Home Manager is only possible if the data request interval is set to <b>Automatic</b>.</p> <p><b>Corrective measures:</b></p> <ul style="list-style-type: none"> <li>• Set the data request interval to <b>Automatic</b> (see Section 11.3.8, page 58).</li> </ul>

Problem	Cause and corrective measures
The animated graphic on the page <b>Current status and Forecast</b> is not displaying any current data.	<p>It is possible that no PV generation meter is connected to the Sunny Home Manager and that too many data capture devices are simultaneously accessing the devices of your PV system.</p> <p><b>Corrective measures:</b></p> <ul style="list-style-type: none"> <li>• Ensure that, apart from the Sunny Home Manager, a maximum of 2 other data capture devices are accessing your system at any one time.</li> </ul>
No data is displayed on the <b>Current</b> tab on the page <b>Load Balance and Control</b> .	<p>Too many data capture devices may be simultaneously accessing the devices of your system.</p> <p><b>Corrective measures:</b></p> <ul style="list-style-type: none"> <li>• Ensure that, apart from the Sunny Home Manager, a maximum of 2 other data capture devices are accessing your system at any one time.</li> </ul>
No data is displayed on the <b>Current</b> tab on the page <b>Energy Balance</b> .	<p>It is possible that no PV generation meter is connected to the Sunny Home Manager and that too many data capture devices are simultaneously accessing the devices of your system.</p> <p><b>Corrective measures:</b></p> <ul style="list-style-type: none"> <li>• Ensure that, apart from the Sunny Home Manager, a maximum of 2 other data capture devices are accessing your system at any one time.</li> </ul>
The diagrams are empty or incomplete.	<p>It might be possible that no energy meters or not all energy meters are connected to the Sunny Home Manager or they are not configured.</p> <p><b>Corrective measures:</b></p> <ul style="list-style-type: none"> <li>• Connect the energy meters to the Sunny Home Manager and configure (see Section 9.1, page 30).</li> </ul>
The diagrams are empty or incomplete.	<p>Sunny Portal might not be able to receive any data from the Sunny Home Manager.</p> <p><b>Corrective measures:</b></p> <ul style="list-style-type: none"> <li>• Make sure that the connection between the Sunny Home Manager and the Sunny Portal is established (see Section 8.3, page 27).</li> </ul>
An exclamation mark is permanently displayed after parameters have been changed.	<p>It might be possible that the Sunny Portal could not transfer the parameters to the Sunny Home Manager.</p> <p><b>Corrective measures:</b></p> <ul style="list-style-type: none"> <li>• Make sure that the connection between the Sunny Home Manager and the Sunny Portal is established (see Section 8.3, page 27).</li> </ul>
Device parameters are not updated.	<p>It is possible that the device cannot be accessed.</p> <p><b>Corrective measures:</b></p> <ul style="list-style-type: none"> <li>• Try to manually update the device parameters.</li> </ul>
Sunny Portal is displaying unrealistic data.	<p>The integrated measuring device of the Sunny Home Manager or the separate SMA Energy Meter might not be correctly connected or configured.</p> <p><b>Corrective measures:</b></p> <ul style="list-style-type: none"> <li>• Ensure that all devices are correctly connected and configured.</li> </ul>

## 18.5 Problems when Configuring and Controlling Radio-Controlled Sockets

Problem	Cause and corrective measures
<p>When configuring the radio-controlled sockets, the time period cannot be set as desired.</p>	<p>The time period must be at least as long as</p> <ul style="list-style-type: none"> <li>• the maximum program runtime</li> </ul> <p><b>or</b></p> <p>the sum of the minimum switch-on time and the minimum switch-off time and the sum of the device operating time and the minimum switch-off time set for the time period.</p> <p><b>Corrective measures:</b></p> <ul style="list-style-type: none"> <li>• When setting the time period, take into consideration the maximum program runtime or the minimum switch-on and switch-off time and the set device operating time.</li> </ul>
<p>I cannot configure the radio-controlled sockets in Sunny Portal or set the operating mode of the radio-controlled sockets using Sunny Portal.</p>	<p>You might not have <b>Installer</b> or <b>Plant Administrator</b> user rights.</p> <p><b>Corrective measures:</b></p> <ul style="list-style-type: none"> <li>• Ask the system administrator to assign you <b>Installer</b> or <b>Plant administrator</b> user rights (see Section 16.4, page 115).</li> </ul>
<p>The Sunny Home Manager cannot control the Edimax smart plug switch.</p>	<p>The password of the Edimax smart plug switch might be unknown to the Sunny Home Manager.</p> <p><b>Corrective measures:</b></p> <ul style="list-style-type: none"> <li>• Enter the password of the Edimax smart plug switch in the Sunny Home Manager properties (see Section 11.3.6, page 58).</li> </ul>
<p>The Edimax smart plug switch registered in the local network is not found by the Sunny Home Manager.</p>	<p>This might be a smart plug switch by Edimax, which is not supported by the Sunny Home Manager.</p> <p><b>Corrective measures:</b></p> <ul style="list-style-type: none"> <li>• Check whether the smart plug switch by Edimax is supported by the Sunny Home Manager.</li> </ul>
<p>The Sunny Home Manager is not communicating with the Fritz!Box.</p>	<p>The smart home settings in the Fritz!Box might not be correct.</p> <p><b>Corrective measures:</b></p> <ul style="list-style-type: none"> <li>• If you selected the option <b>Login without password</b> for the Fritz!Box login when you set up the smart home control, in the Fritz!Box itself under the tab <b>Login for access from the home network</b> the option <b>Login with keystroke</b> must not be activated.</li> </ul>
<p>The Sunny Home Manager is not able to switch my AVM radio-controlled socket.</p>	<p>In the settings of the FRITZ!Box, it is specified that the radio-controlled socket can be switched via smart home devices.</p> <p><b>Corrective measures:</b></p> <ul style="list-style-type: none"> <li>• Check whether the settings in Sunny Portal match the settings for login of the FRITZ!Box.</li> <li>• In the Fritz!Box settings, select the respective device under <b>Home network &gt; Smart home &gt; Smart home devices</b> and click on the button for editing the properties. Go to <b>Manual switching</b> and enable the <b>Permit manual switching by phone, app, user interface or other smart home device</b> checkbox.</li> </ul>



Problem	Cause and corrective measures
The Sunny Home Manager cannot establish a connection to the AVM radio-controlled sockets.	<p>The TR-064 interface of the FRITZ!Box might be disabled.</p> <p><b>Corrective measures:</b></p> <ul style="list-style-type: none"> <li>The interface TR-064 must be enabled in the FRITZ!Box under network settings: Select <b>Home network &gt; Home network overview &gt; Network settings</b> in the FRITZ!Box settings. Then enable the <b>Allow access for applications</b> option under Home network share (see manufacturer manual).</li> </ul>
The Sunny Home Manager switches my AVM radio-controlled socket even though this is not configured in Sunny Portal.	<p>An automatic switching program is stored in the FRITZ!Box.</p> <p><b>Corrective measures:</b></p> <ul style="list-style-type: none"> <li>Delete all automatic switching programs.</li> </ul>
The Sunny Home Manager switches my AVM radio-controlled socket even though this is not configured in Sunny Portal.	<p>The radio-controlled socket might have assumed a predefined state due to a restart, for example.</p> <p><b>Corrective measures:</b></p> <ul style="list-style-type: none"> <li>After a restart, configure the switching state of the AVM radio-controlled socket to "Last state".</li> </ul>

## 18.6 Using the Sunny Home Manager Assistant in case of network problems

The Sunny Home Manager Assistant only has to be used in exceptional cases.

The Sunny Home Manager Assistant will help you configure the Sunny Home Manager for your network if the Sunny Home Manager does not automatically connect to Sunny Portal.

In addition, you can use the Sunny Home Manager Assistant to display the latest connection status to Sunny Portal and the network settings and the connected BLUETOOTH devices, and save these as a log file. If servicing should be necessary, the Service can use this log file to analyze the problem.

The following operating systems are supported by the Home Manager Assistant (firewall shares may need to be confirmed when using for the first time):

- Microsoft Windows from version Vista
- Linux from Kernel 2.6.12 with Java Runtime Environment version 6
- Apple macOS from version 1.6, with Java Runtime Environment from version 6

### Procedure:

1. Use a network cable to connect the computer to the same router to which the Sunny Home Manager is also connected.
2. In the download area at [www.SMA-Solar.com](http://www.SMA-Solar.com), download the Sunny Home Manager Assistant for the operating system of your computer.
3. Start the Sunny Home Manager Assistant by double-clicking on the file name.
4. Follow the Sunny Home Manager Assistant instructions.

## 18.7 Messages in the system logbook

### Messages regarding active power limitation

Problem	Cause and corrective measures
Message in the system logbook: <b>Supplied power has exceeded the permitted value several times.</b>	Although the function <b>Limitation of active power feed-in</b> is activated, more than the maximum permitted active power has been fed into the utility grid. <b>Corrective measures:</b> <ul style="list-style-type: none"> <li>• Ensure that the feed-in meter is configured correctly (see Section 11.3.11, page 61).</li> <li>• Ensure that the parameter <b>Operating mode active power setting</b> must be set to <b>Active power limitation P via system control</b> or to <b>External specification</b> for the PV and hybrid inverters.</li> </ul>
Message in the system logbook: <b>Act. power limitation deactivated due to incorr. configuration.</b>	The function <b>Limiting of the active power feed-in</b> was deactivated by Sunny Home Manager because the system configuration in Sunny Portal was faulty. <b>Corrective measures:</b> <ul style="list-style-type: none"> <li>• This message can appear while making changes to the Sunny Home Manager system, e.g. upon device replacement. In this case, no action is needed.</li> <li>• If the message appears over an extended time period, contact the Service (see Section 23, page 140).</li> </ul>
Message in the system logbook: <b>Event: act. power limitation activated w/o regard to own consumption</b>	The function <b>Limiting of the active power feed-in</b> is faulty because there is no data from the feed-in meter. Risk of yield loss because the self-consumption of the household cannot be taken into account. <b>Corrective measures:</b> <ul style="list-style-type: none"> <li>• Ensure that the feed-in meter is working and correctly connected.</li> </ul>
Message in the system logbook: <b>Inverter does not respond to active power limitation</b>	At least one inverter is not responding to limit the active power feed-in. In this case, the Sunny Home Manager initiates stronger active power limitation in the remaining inverters. Consequently, the maximum permitted active power feed-in is complied with. If the message <b>Fed-in power has repeatedly exceeded the permitted value</b> appears on the same day, an error is present. <b>Corrective measures:</b> <ul style="list-style-type: none"> <li>• Ensure that the parameter <b>Operating mode active power setting</b> must be set to <b>Active power limitation P via system control</b> or to <b>External specification</b> for the PV and hybrid inverters.</li> </ul>

### Messages regarding communication via data exchange protocol

Devices having a specific interface for data exchange, e.g. SEMP or EEBus, can communicate directly with the Sunny Home Manager via a so-called EM (Energy Management) gateway.

The following placeholders are used in the table below:

- XXXX - is a placeholder for the used data exchange protocol SEMP or EEBus

- YYYY - is a placeholder for the respective 4-digit error number

Problem	Cause and corrective measures
<p>Message in the system logbook:  <b>EM gateway not found:</b>  <b>XXXX, name:</b></p>	<p>The gateway is not connected to the local network.</p> <p><b>Corrective measures:</b></p> <ul style="list-style-type: none"> <li>• Check whether all network cable plugs are inserted and locked.</li> </ul>
<p>Message in the system logbook:  <b>EM gateway not found:</b>  <b>XXXX, name:</b></p>	<p>The voltage supply of the gateway is faulty.</p> <p><b>Corrective measures:</b></p> <ul style="list-style-type: none"> <li>• Check whether the power plug of the gateway is plugged into the outlet.</li> </ul>
<p>Message in the system logbook:  <b>EM gateway not found:</b>  <b>XXXX, name:</b></p>	<p>The gateway could not be found by the Sunny Home Manager.</p> <p><b>Corrective measures:</b></p> <ul style="list-style-type: none"> <li>• Restart the gateway (see manual of the gateway).</li> </ul>
<p>Message in the system logbook:  <b>EM gateway not found:</b>  <b>XXXX, name:</b></p>	<p>The Sunny Home Manager and the gateway are located in different local networks.</p> <p><b>Corrective measures:</b></p> <ul style="list-style-type: none"> <li>• Connect the gateway and the Sunny Home Manager to the same network switch/router.</li> </ul>
<p>Message in the system logbook:  <b>EM gateway not found:</b>  <b>XXXX, name:</b></p>	<p>The Sunny Home Manager and the gateway are configured for different IP subnets.</p> <p><b>Corrective measures:</b></p> <ul style="list-style-type: none"> <li>• If your router supports DHCP, configure the Sunny Home Manager (default setting) and the gateway to DHCP (see manual of the gateway).</li> <li>• If your router does not support DHCP, manually assign IP addresses in the same subnet for the Sunny Home Manager and the gateway (see manual of the respective device).</li> </ul>
<p>Message in the system logbook:  <b>EM gateway not found:</b>  <b>XXXX, name:</b></p>	<p>The voltage supply of the device is faulty.</p> <p><b>Corrective measures:</b></p> <ul style="list-style-type: none"> <li>• Check whether the power plug of the device is plugged into the outlet.</li> </ul>
<p>Message in the system logbook:  <b>EM gateway not found:</b>  <b>XXXX, name:</b></p>	<p>The device is not connected to its gateway.</p> <p><b>Corrective measures:</b></p> <ul style="list-style-type: none"> <li>• Check whether the communication between the device and the gateway is working. The device might be outside the range of its gateway (e.g. with power-line communication).</li> </ul>
<p>Message in the system logbook:  <b>EM gateway not found:</b>  <b>XXXX, name:</b></p>	<p>The device could not be found by the Sunny Home Manager.</p> <p><b>Corrective measures:</b></p> <ul style="list-style-type: none"> <li>• Restart the device (see manual of the device).</li> </ul>
<p>Message in the system logbook:  <b>EM gateway not found:</b>  <b>XXXX, name:</b></p>	<p>One or more devices are not correctly configured in the gateway or for the smart grid.</p> <p><b>Corrective measures:</b></p> <ul style="list-style-type: none"> <li>• Configure the device for its gateway (see manual of the gateway).</li> <li>• Configure the device for the smart grid (see manual of the respective device).</li> </ul>

Problem	Cause and corrective measures
<p>Message in the system logbook:  <b>Communication with the EM gateway disturbed: XXXX, name:</b></p>	<p>The gateway is not connected to the local network.</p> <p><b>Corrective measures:</b></p> <ul style="list-style-type: none"> <li>• Check whether all network cable plugs are inserted and locked.</li> </ul>
<p>Message in the system logbook:  <b>Communication with the EM gateway disturbed: XXXX, name:</b></p>	<p>The gateway is not communicating correctly with the Sunny Home Manager.</p> <p><b>Corrective measures:</b></p> <ul style="list-style-type: none"> <li>• Restart the gateway (see manual of the gateway).</li> </ul>
<p>Message in the system logbook:  <b>Communication with the EM gateway disturbed: XXXX, name:</b></p>	<p>The device is not communicating correctly with its gateway.</p> <p><b>Corrective measures:</b></p> <ul style="list-style-type: none"> <li>• Check whether the communication between the device and the gateway is working. The device might be outside the range of its gateway (e.g. with power-line communication).</li> <li>• Restart the gateway (see manual of the gateway).</li> <li>• Restart the device (see manual of the device).</li> </ul>
<p>Message in the system logbook:  <b>EM gateway has incompatible firmware: XXXX, name:</b></p>	<p>The supported firmware version is not installed on the gateway.</p> <p><b>Corrective measures:</b></p> <ul style="list-style-type: none"> <li>• Update the gateway to the supported firmware version (see manual of the gateway).</li> </ul>
<p>Message in the system logbook:  <b>EM communication: An internal error has occurred (error number: YYYY)</b></p>	<p>A software error has occurred on the Sunny Home Manager.</p> <p><b>Corrective measures:</b></p> <ul style="list-style-type: none"> <li>• Reset the Sunny Home Manager (see Section 11.7.1, page 66)</li> </ul>

## 19 Decommissioning

### 19.1 Decommissioning the Sunny Home Manager

#### Procedure:

1. Disconnect the Sunny Home Manager from the voltage supply.
2. Remove the cables and dismount the Sunny Home Manager.
3. Disconnect the Sunny Home Manager from the voltage supply.

4. **⚠ DANGER**

#### **Danger to life due to electric shock**

Lethal voltages are present at the connection point of the utility grid.

- Disconnect the connection point from the utility grid via the disconnection device (e.g. in the distribution board).

5. Removing the cables and dismounting the Sunny Home Manager
6. Unplug the network cable from the network terminal of the Sunny Home Manager.
7. Unplug the other end of the network cable from the router.
8. Remove the Sunny Home Manager from the top-hat rail:
 

Press the top-hat rail locking mechanism located underneath the Sunny Home Manager downwards using a screwdriver. Tilt the lower edge of the Sunny Home Manager forwards and remove upwards from the top-hat rail.

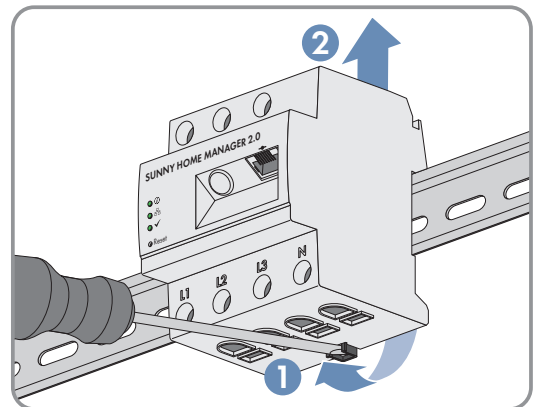

### 19.2 Packing the Product for Shipment

- Pack the product for shipping. Use the original packaging or packaging that is suitable for the weight and size of the product.

### 19.3 Disposing of the Product

- Dispose of the product in accordance with the locally applicable disposal regulations for electronic waste.

## 20 Appendix

### 20.1 Application example forecast-based battery charging

#### 20.1.1 Objective and Background Information

##### Objective of using battery storage-systems

The objective of using battery storage systems is to not feed excess PV energy that cannot currently be self-consumed into the utility grid, but instead to store it temporarily in batteries. It is then available and can be used when the self-generated PV energy is not sufficient, e.g. on a gloomy day, in the evening or at night.

The duration of use can be set to 24 h or 48 h.

System operators are less dependent on the electricity purchased from the utility grid and increase their self-sufficiency quota.

##### Background information on forecast-based battery charging

###### Without forecast-based battery charging

- If the battery is perhaps already fully charged by noon and can no longer take in any excess PV energy. This then leads to the fact that the PV feed-in power at the point of interconnection has to be "derated" if the nominal PV system power exceeds the maximum feed-in power specified by the grid provider at the point of interconnection (see Limitation of active power feed-in).
- this can result in faster calendar aging of the battery if the state of charge is at 100% frequently and over longer periods of time.

###### The following features of the Sunny Home Manager play an essential role for the forecast-based battery charging:

- PV yield forecast  
By using a weather forecast based on Internet data and by specifically adapting this to the local conditions, the Sunny Home Manager can accurately predict solar irradiation for a few hours to a few days (48h).
- Consumption forecast  
The Sunny Home Manager creates an individual load profile on the consumption behavior of the system.
- PV curtailment forecast  
From generation and consumption data the Sunny Home Manager identifies when the PV nominal system power would exceed the specified feed-in power at the point of interconnection. Without forecast-based battery charging this PV energy would have to be derated or would not be generated – and thus would get lost.
- Prioritization of loads  
A preferred consideration of the battery charging ensures sufficient availability of energy e.g. in the evening and night-time hours.
- Specifying a minimum load capacity of the battery  
Since a purely forecast-based charging of the battery can lead to a lack of sufficient stored energy available when required, a percentage value can be set for the forecast-based charging of the battery. The battery is definitely charged up to this value before the Sunny Home Manager enables the forecast-controlled battery charging.

###### Ideally

- all loads are controlled so as to avoid derating losses and to be able to cover the household's energy demand exclusively with self-produced PV energy.

###### The result is that the battery

- always has sufficient PV energy stored to satisfy the current demand.
- still has capacities to absorb PV energy even at the midday peak.

- exhibits rarely and only briefly a state of charge of 100%.

## 20.1.2 Setting up Forecast-Based Battery Charging

### Preliminary considerations and requirements:

- To calculate the expected PV generation, the exact input of the system location (latitude, longitude, altitude) (see Section 10.1.2, page 38) as well as the nominal system power (string configuration) (see Section 10.2, page 40) are required.
- In order to optimize the energy costs, the feed-in tariff and electricity tariff must be entered (see Section 10.4.2, page 42) .  
The criteria according to which the costs are to be optimized must be set in the optimization target (see Section 10.4.7, page 47).
- "Learned" energy balance data (at least load profile of the past 14 days) should be available.
- If the local grid operator requires a limiting of the active power feed-in (e.g. 70%), this must be specified here (see Section 10.4.3, page 43).
- As the battery should always be able to start up when energy is needed but also not being produced by the PV system, it makes sense
  - to specify the time period as liberally as possible.
  - to configure the battery as an optional load, but with a higher priority than a load with a lower power (e.g. washing machine or dishwasher) (see Section 12.4.7, page 81).
- So that the battery still has capacities during PV generation peak periods (e.g. midday peak) and curtailment can be avoided, a percentage value for the state of charge should be specified, from which the Sunny Home Manager should consider other loads before the battery continues to charge.

### Procedure:

1. On the configuration page **PV system properties** under the tab **PV system data** check the setting of the PV system location entry and adjust if necessary.
2. On the configuration page **PV system properties** under the tab **String configuration** check the string configuration and adjust if necessary .
3. On the configuration page **PV system properties** under the tab **Parameters** check the following settings and adjust if necessary:
  - **Feed-in tariff and electricity tariff**
  - **Limitation of active power feed-in**
  - **Optimization target**
4. On the configuration page **Load overview and planning** select the load and configure the **Load properties**:  
Use the slider to set the **Priority of the Load**.
5. On the configuration page **Device overview** select the Sunny Home Manager and call up its **Device properties**.
6. In the area **SMA Smart Home settings** make the following settings:
7. In the **EEBUS protocol** field place a checkmark: **Active**
8. If the active power limitation of the system is active, in the field **Forecast-based battery charging** place a checkmark: **Active**

9. In the field **Required state of charge (SOC) for forecast-based charging**, change the preset value from 0% if applicable (e.g. to 60%).  
The set value indicates the percentage of the battery charge that must be reached before the Sunny Home Manager activates the forecast-based battery charging function, i.e. up to this value the function forecast-based charging is deactivated.
10. In the field **Charging of battery prior to optional loads** place a checkmark: **Active**  
This way you ensure that the battery is first charged before the Sunny Home Manager considers other loads such as a heating element, for example.



## 21 Technical Data

### Energy Manager

Connection to the local router	via Ethernet cable (10/100 Mbit/s, RJ45 plug)
Connecting SMA inverters	Ethernet or WLAN via local router
Connecting loads	<ol style="list-style-type: none"> <li>1. Direct data connection (EEMBus, SEMP)</li> <li>2. Indirect data connection (compatible switchable devices)</li> </ol>

### Integrated measuring device

Measurement accuracy	Energy Manager	Voltage: $\pm 0.5\%$
Accuracy class according to IEC 61557-12		Current: $\pm 0.5\%$
Based on measured value		Voltage: $\pm 0.5\%$
		Active power: $\pm 1.0\%$
		Reactive power: $\pm 1.0\%$
		Power factor: $\pm 1.0\%$
		Active Energy: class 1
		Reactive energy: class 1

Based on IEC 62053-22 or -23 (typical)

When using external current transformers, the respective measuring accuracy must be taken into account

Measuring cycle	200 ms, 600 ms or 1000 ms
-----------------	---------------------------

### Max. number of devices in the system

Total number of devices in the system	up to 24
<ul style="list-style-type: none"> <li>• of which devices as loads in active energy management</li> </ul>	up to 12

### Inputs (voltage and current)

Nominal voltage	110 V / 230 V / 400 V
Frequency	50 Hz / 60 Hz
Nominal current/limiting current per line conductor	5 A/63 A (>63 A can be covered via external current transformers)
Short-circuit load carrying capacity	max. 6 kA
Connection cross-section	10 mm <sup>2</sup> to 25 mm <sup>2</sup> (for application up to 63 A)
Torque for screw terminals	2.0 Nm

### Ambient Conditions in Operation

Ambient temperature	-25 °C to +40 °C
Storage temperature range	-25 °C to +70 °C

Pollution Degree	2
Protection class (as per IEC 62103)	II
Degree of protection (to IEC 60529)	IP20
Maximum permissible value for the relative humidity (non-condensing)	5% to 90%
Altitude above MSL	0 m to 2000 m

### General Data

Width x height x depth	70 mm x 85 mm x 65 mm
Individual units DIN rail	4
Weight	0.3 kg
Mounting location	Switch or meter cabinet
Mounting type	Top-hat rail mounting
Status display	3 x LED
Self-consumption	< 3 W

### Equipment

Operation and visualization	via Sunny Portal and Sunny Portal Pro
Update function for the Sunny Home Manager and the connected SMA devices	automatically
Warranty	2 years
Certificates and approvals	<a href="http://www.SMA-Solar.com">www.SMA-Solar.com</a>

### Accessories

SMA Energy Meter as complement to integrated Measuring devices	Precise three-phase measuring, connection via Ethernet in the local network.
Model number	HM-20

## 22 Declarations of Conformity

### 22.1 EU Declaration of Conformity

within the scope of the EU directives

- Electromagnetic compatibility 2014/30/EU (29.3.2014 L 96/79-106) (EMC)
- Low Voltage Directive 2014/35/EU (29.3.2014 L 96/357-374) (LVD)
- Restriction of the use of certain hazardous substances 2011/65/EU (L 174/88, June 8, 2011) and 2015/863/EU (L 137/10, March 31, 2015) (RoHS)



SMA Solar Technology AG confirms herewith that the products described in this document are in compliance with the fundamental requirements and other relevant provisions of the above-mentioned directives. The entire EU Declaration of Conformity can be found at [www.SMA-Solar.com](http://www.SMA-Solar.com).

### 22.2 UK Declaration of Conformity

according to the regulations of England, Wales and Scotland

- Electromagnetic Compatibility Regulations 2016 (SI 2016/1091)
- Electrical Equipment (Safety) Regulations 2016 (SI 2016/1101)
- Radio Equipment Regulations 2017 (SI 2017/1206)
- The Restriction of the Use of Certain Hazardous Substances in Electrical and Electronic Equipment Regulations 2012



SMA Solar Technology AG confirms herewith that the products described in this document are in compliance with the fundamental requirements and other relevant provisions of the above-mentioned regulations. The entire UK Declaration of Conformity can be found at [www.SMA-Solar.com](http://www.SMA-Solar.com).

## 23 Contact

You can find your country's contact information at:



<https://go.sma.de/service>



ENERGY  
THAT  
CHANGES



[www.SMA-Solar.com](http://www.SMA-Solar.com)

